

**SUTPHEN CORPORATION
MODEL SLR 75
AERIAL LADDER
OPERATOR AND MAINTENANCE MANUAL**



SUTPHEN

IMPORTANT

READ AND UNDERSTAND THIS MANUAL BEFORE OPERATING

FAILURE TO USE, UNDERSTAND, AND FOLLOW PROPER USAGE INSTRUCTIONS AS MADE AVAILABLE BY SUTPHEN CORPORATION/OPERATOR'S MANUAL, VARIOUS VENDOR SUPPLIED LITERATURE, GUIDELINES OF N.F.P.A., I.S.F.S.I., O.S.H.A., ETC., COULD CAUSE SERIOUS INJURY AND/OR DEATH.

**SUTPHEN
Since 1890**

Rev. 2 - May 2024



Chapter 1 Operator Manual

	<u>Page</u>
1.1 Introduction.....	1-3
1.2 Aerial Ladder Operation	1-5
<i>Operation Safety Points</i>	1-5
1.3 Cab Note	1-8
<i>Cab Tilt</i>	1-8
1.4 Rated Capacities	1-8
1.5 Safety Tags.	1-8
<i>Warning/Danger/Caution Labels List</i>	1-9
1.6 Cab Setup Procedure	1-22
<i>Locating the Vehicle</i>	1-22
<i>Activating the Hydraulic System</i>	1-22
1.7 Cab Setup for Fire Pump Operation.	1-24
1.8 Setup for Simultaneous Tower and Pump Operations.....	1-25
1.9 Aerial Setup Procedures	1-26
1.10 Safety Pins	1-27
1.11 Upper Power	1-28
1.12 Short Jacking.....	1-29
1.13 Ladder Function Controls	1-30
<i>Elevation</i>	1-31
<i>Extend/Retract</i>	1-31
<i>Rotation</i>	1-32
<i>High Speed Controls</i>	1-33
<i>Auxiliary Motor Switch</i>	1-33
<i>Additional Pedestal Controls</i>	1-34



	Rung Alignment	1-34
	Panel Light Switch	1-34
	Alignment Light	1-35
1.14	Ladder Positioning	1-35
1.15	Climbing Ladder or Using as an Escapeway.....	1-35
1.16	Safety Interlock System	1-36
	<i>Interlock Jack Release</i>	1-36
1.17	Waterway and Nozzle.....	1-37
	<i>Operation and Use</i>	1-37
	<i>Draining the Waterway</i>	1-38
1.18	Optional Breathing Air System.....	1-38
1.19	Return Aerial to Travel Position.....	1-39
	<i>Retract the Tower</i>	1-39
	<i>Lower the Tower</i>	1-40
	<i>Remove Wheel Chocks</i>	1-40
	<i>Retract the Stabilizers</i>	1-40

Chapter 2
Maintenance Manual

		<u>Page</u>
2.1	Aerial Maintenance	2-2
	<i>Stabilizers</i>	2-2
	<i>Main Lift Cylinders</i>	2-2
	<i>Pivot Shaft Bearings</i>	2-2
	<i>Turntable Bearing</i>	2-2
	<i>Rotation Gear Reducer</i>	2-3
	<i>Drive Gears</i>	2-4



	<i>Sheaves and Cables</i>	2-4
2.2	Extension System.....	2-4
	<i>Cable Adjustment Procedure</i>	2-4
	<i>Slide Blocks</i>	2-7
	<i>Waterway and Seals</i>	2-8
2.3	Water Lubrication Procedure.....	2-9
	<i>Waterway Nozzle</i>	2-9
	<i>Hydraulic Oil Tank</i>	2-9
	<i>Hydraulic Tank Fill Instructions</i>	2-11
2.4	High Pressure Filtration System.....	2-13
2.5	Maintenance of Structure.....	2-13
	<i>Aluminum Tower Structure</i>	2-13
	<i>Turntable Attachments</i>	2-14
	<i>Attachment of Support Structure to Truck Frame</i>	2-15
	<i>Aerial Tower and Ice Build Up</i>	2-15
	<i>Aerial Tower Lubrication and Maintenance Schedule</i>	2-17
	<i>Torque Specifications</i>	2-20
	<i>Walk Around Checks for Mobile Fire Apparatus</i>	2-21
	<i>Draining & Winterizing Trucks</i>	2-25

Chapter 3

Warranty

	<u>Page</u>
Aerial Platform or Aerial Ladder Structural and Corrosion Warranty	
Thirty (30) Years.....	3-2
Aerial Platform and Aerial Ladder Mechanical Warranty	
Two (2) Years	3-3

Chapter 1

Operator Manual

	<u>Page</u>
1.1 Introduction.....	1-3
1.2 Aerial Ladder Operation	1-5
<i>Operation Safety Points</i>	1-5
1.3 Cab Note	1-8
<i>Cab Tilt</i>	1-8
1.4 Rated Capacities	1-8
1.5 Safety Tags.	1-8
<i>Warning/Danger/Caution Labels List</i>	1-9
1.6 Cab Setup Procedure	1-22
<i>Locating the Vehicle</i>	1-22
<i>Activating the Hydraulic System</i>	1-22
1.7 Cab Setup for Fire Pump Operation.	1-24
1.8 Setup for Simultaneous Tower and Pump Operations.....	1-25
1.9 Aerial Setup Procedures	1-26
1.10 Safety Pins	1-27
1.11 Upper Power	1-28
1.12 Short Jacking.....	1-29
1.13 Ladder Function Controls	1-30
<i>Elevation</i>	1-31
<i>Extend/Retract</i>	1-31
<i>Rotation</i>	1-32
<i>High Speed Controls</i>	1-33
<i>Auxiliary Motor Switch</i>	1-33
<i>Additional Pedestal Controls</i>	1-34



Rung Alignment	1-34
Panel Light Switch	1-34
Alignment Light	1-35
1.14 Ladder Positioning	1-35
1.15 Climbing Ladder or Using as an Escapeway.....	1-35
1.16 Safety Interlock System	1-36
<i>Interlock Jack Release</i>	1-36
1.17 Waterway and Nozzle.....	1-37
<i>Operation and Use</i>	1-37
<i>Draining the Waterway</i>	1-38
1.18 Optional Breathing Air System.....	1-38
1.19 Return Aerial to Travel Position.....	1-39
<i>Retract the Tower</i>	1-39
<i>Lower the Tower</i>	1-40
<i>Remove Wheel Chocks</i>	1-40
<i>Retract the Stabilizers</i>	1-40

1.1 Introduction

This manual has been prepared with the assistance of service and engineering specialists to acquaint you with the operation and maintenance of your new apparatus. You are urged to read this manual carefully. Following the instructions and recommendations in this manual will help ensure the safe and enjoyable operation of your apparatus.

After you have read this manual, it should be stored in the apparatus or another location which enables quick and easy reference for all firefighters.

Throughout this manual, the safety signal words **WARNING**, **DANGER**, and **CAUTION** appear. These serve as reminders to follow all instructions carefully. Failure to follow instructions can cause personal injury or damage to your apparatus.

This manual has been written to help in the setup and use of the tower during emergencies and training.

There may be circumstances that arise throughout the life of this apparatus which do not appear in this manual. At all times, common sense and safety should be your first consideration.

Sutphen knows your apparatus best and has the parts and factory-trained technicians available to keep your apparatus in an ever-ready state. Sutphen Corporation works towards giving you complete satisfaction. Please do not hesitate to contact Sutphen Corporation at 1-800-343-2712.



Auxiliary ground pads should always be used under the outrigger feet when operating the aerial tower.

Do not use auxiliary ground pads under the rear jacks unless they are metal, as these jacks are used as a grounding point.

Safety lock pins on stabilizers shall always be in place.

Never move the vehicle with stabilizers in contact with ground.

Most problems encountered with operation of the tower are caused by inadequate maintenance. To keep the tower fully operational, routine lubrication policies must be followed.

The aerial should be inspected and tested annually in accordance with NFPA 1910, Testing Fire Department Aerial Apparatus.

Frequently inspect the chassis and running gear and maintain in good mechanical condition following recommended schedules in this manual. The aerial tower is of no use unless it can be transported to where it is needed. Careful, safe driving rules should be observed for the same reason.

Carefully and frequently check and inspect the entire aerial for loose bolts or rivets, un-lubricated bearing surfaces, bent, warped, or twisted parts, hydraulic leaks, defective electric control equipment, etc. Follow the recommended maintenance schedules in this manual.

All members should frequently practice the different phases of aerial operations.

Never set up the aerial on marshy ground, freshly filled ground, or other soft surface.

1.2 Aerial Ladder Operation

Operation Safety Points

The aerial ladder is only as good or as safe as the operator is competent. Continued training and familiarization is essential.

An operator **MUST** be at the lower control station anytime the aerial is being operated.

Do not operate turntable controls while personnel are climbing the tower.

Personnel should use an approved life belt when operating on the aerial tower. At night, the entire aerial tower should be well lighted.

Do not forcefully extend the end of the aerial device against a structure.

Never use the aerial device as a battering ram.

Never use the aerial for pulling down walls or structural members.

Never willingly or intentionally abuse an aerial by careless handling, overloading, or use for which it was not designed.

Operate the aerial with deliberate motions and smooth application of power.

Stabilizers with ground pads should always be used when operating the aerial ladder.

Safety locks on stabilizers should always be in place.

Training and practice with the apparatus on a regular basis is a must for safe operation.



Never apply opposing alternating control when operating the aerial, either in a side-to-side motion, a front-to-rear motion, or an up-and-down motion. This may set up an accelerated oscillation, which could put undue strain on the structure and cause immediate or eventual failure of the aerial tower and injury to the occupants and bystanders.

Do not overload the aerial. Learn and observe the load limit indicated at the operator's positions.

When raising an aerial platform to rescue people at roofs or windows, avoid raising the platform in line with the people. Either raise off to one side and rotate to the people or raise perpendicular to them and rotate toward them. This is because panic-stricken persons seeing the platform within reach below them could try jumping into it.

Although the aerial is designed for one person setup, it is a good safety practice to designate a person to observe the right-side stabilizer when the stabilizers are being set up. This person can place the stabilizer pad and observe that it is placed evenly and correctly and that the stabilizer is set properly.

Many accidents with aerial devices nationwide occur during nonemergency operation. For this reason, the aerial should not be operated by one person alone. Operators checking out or operating the tower alone in front of the station can forget something or be overconfident and get into trouble. “Two heads are better than one”.

Never allow an untrained person or a person who is not thoroughly familiar with this aerial to operate it unless constantly supervised.

That operator must:

1. Be capable of spotting the vehicle properly.
2. Be able to stabilize the vehicle properly.
3. Know the location of every control.
4. Know what each control does and how it works.
5. Be able to operate all controls smoothly and safely.
6. Know the location of safety devices, how they work, and how to operate them.
7. Be familiar with the loads that the aerial can safely accommodate under various operating conditions.
8. Be aware of how to operate the aerial under unusual circumstances.

When you consider the cost of an aerial platform, the lives that could be at stake, and the damage that could occur to the equipment, the importance of practice and training becomes very clear.



WARNING

Before operating this apparatus you must:

1. *Be thoroughly familiar with this instruction manual.*
2. *Be thoroughly trained in the operation of this apparatus.*
3. *Operate this apparatus in strict accordance with the manufacturer's recommendations.*
4. *Operate this apparatus in accordance with departmental rules and regulations.*
5. *Always set up the apparatus on concrete, blacktop, or gravel. Surface must be firm and solid.*

Failure to do so could result in injury or death to persons operating or working on or around this apparatus.

Failure to do so could also result in damage to this apparatus.



1.3 Cab Note

Cab Tilt

The ladder must be clear of the cab prior to tilting the cab. A prox switch mounted to the tilt sub frame (left front) monitors cab position. Sensors in the ladder monitor rotation and elevation. The ladder can be rotated to either side of the cab to provide clearance. The ladder can also be elevated to provide enough clearance to tilt the cab. Upper Ladder Power must be on to tilt the cab.

1.4 Rated Capacities

75' Rear Mount Aerial

The rated capacity of the 75' aerial platform is 500 lbs. with water in the waterway, 750 lbs. without water in the waterway, in any position of operation.



WARNING

DO NOT exceed the rated capacities.

1.5 Safety Tags

On the following pages are the various safety tags found on the apparatus. All of the tags found here may not be used on your particular vehicle, as some are related to optional equipment. Should any of these tags become damaged or lost throughout the life of your vehicle, please contact Sutphen Corporation at 1-866-287-5549 for replacements.

Operator Manual

WARNING / DANGER / CAUTION LABELS LIST

Tag 010	Alignment Light	Tag 370	Platform Equipment
Tag 015	Aerial Modification Warning	Tag 371	Drain Yoke Caution
Tag 016	Oil Caution	Tag 375	Set Rear Jacks Caution
Tag 017	Avoid Electrocutation Danger	Tag 381	ABS Code Switch
Tag 018	Pinch Point Caution	Tag 382	Pressurized Inlets Warning
Tag 019	Stand Clear Crushing Injury Warning	Tag 385	Jump Stud
Tag 020	Aerial Electrocutation Danger	Tag 395C	Pump Overheat Procedure
Tag 022	Climb Boom Danger	Tag 405	Power Line Down
Tag 023	Aerial Data	Tag 406	Manual Override Outrigger Controls
Tag 036	Fire Caution	Tag 407B	Turntable Area Instruction
Tag 037	Enclosed Seats Warning	Tag 408B	Down to Lock
Tag 038	Fumes Caution	Tag 410	Do Not Walk Warning
Tag 038-1	Horizontal Fumes Caution	Tag 416	Safety Chain Fastened Warning
Tag 055	Battery Safety Precaution	Tag 417	Engage Generator Instruction
Tag 056	Explosion Warning	Tag 427B	Bumper Warning
Tag 057A	Seated & Belted Warning	Tag 428	Pump Valve Handle Warning
Tag 058	Traction Warning	Tag 430	Sutphen Towers Pump Data
Tag 059	Fan Warning	Tag 431	Chassis Data
Tag 060	Close Crosslay Cover Warning	Tag 432	Fluid Data
Tag 066	Stand Clear of Outrigger Warning	Tag 433	Power Source Specs.
Tag 21B	Lifting Eye Warning	Tag 434B	Front Suction Elbow Caution
Tag 281	Tire Chains Instruction	Tag 437	Ladder Rack Up/Down
Tag 282	Stabilizer Interlock System	Tag 438	Waterway Valve Override
Tag 310	Computer Code Switch	Tag 440	Equipment Weight Limit
Tag 322	Lowering Cab Warning	Tag 442B	Lifting Eye Warning
Tag 323A	Cab Safety Precautions	Tag 446	Lifting Eye Capacity
Tag 324	Cab Tilt	Tag 448	Differential Lock Engagement
Tag 325	Cab Tilt Latch	Tag 449B	Water Tank Refill Caution
Tag 326	Aerial Rappel Warning	Tag 450B	Pressure Governor RPM Warning
Tag 327	Leveling Override Instruction	Tag 452	Generator PTO
Tag 328	Open Valves	Tag 454B	Generator Wattage Caution
Tag 365	Vehicle Capacity & Height Warning	Tag 455	Ladder Belt Tie-Off Point Warning
Tag 368	Engage PTO Instruction	Tag 499	Sutphen Logo



Sutphen Tag 10
IC Assembly P/N 3000573-0003
IC Label P/N 3000575-0003
IC Bezel P/N 3000574
Assembly, Size B Message Bezel with Alignment Light Label

TAG 010



Sutphen Tag 15-A
IC Assembly P/N 3000587-0017
IC Label P/N 3000588-0017
IC Bezel P/N 3000586
Assembly, Size D Message Bezel with Aerial Modification Warning Label

TAG 015



Sutphen Tag 16
IC Assembly P/N 3000587-0022
IC Label P/N 3000588-0022
IC Bezel P/N 3000586
Assembly, Size D Message Bezel with Oil Caution Label

TAG 016



Sutphen Tag 17
IC Assembly P/N 3000587-0025
IC Label P/N 3000588-0025
IC Bezel P/N 3000586
Assembly, Size D Message Bezel with Avoid Electrocution Danger Label

TAG 017



Sutphen Tag 18-A
IC Assembly P/N 3000587-0021
IC Label P/N 3000588-0021
IC Bezel P/N 3000586
Assembly, Size D Message Bezel with Pinch Point Caution Label

TAG 018



Sutphen Tag 19-A
IC Assembly P/N 3000587-0002
IC Label P/N 3000588-0002
IC Bezel P/N 3000586
Assembly, Size D Message Bezel with Stand Clear Crushing Injury Warning Label

TAG 019

Operator Manual



Sutphen Tag 20
 IC Assembly P/N 3000587-0026
 IC Label P/N 3000588-0026
 IC Bezel P/N 3000586
 Assembly, Size D Message Bezel with Aerial Electrocution Danger Label

TAG 020



Sutphen Tag 21-B
 IC Label P/N 3001032-0001
 Lifting Eye Warning Label

TAG 021B



Sutphen Tag 22
 IC Assembly P/N 3000587-0027
 IC Label P/N 3000588-0027
 IC Bezel P/N 3000586
 Assembly, Size D Message Bezel with Climb Boom Danger Label

TAG 022

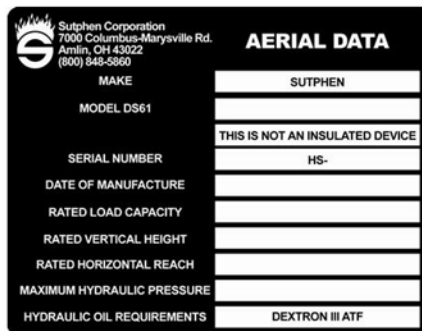

Sutphen Tag 23
 IC Label P/N 3001025-0001
 Aerial Data Label

TAG 023



Sutphen Tag 36-A
 IC Assembly P/N 3000587-0018
 IC Label P/N 3000588-0018
 IC Bezel P/N 3000586
 Assembly, Size D Message Bezel with Fire Caution Label

TAG 036



Sutphen Tag 37-A
 IC Assembly P/N 3000587-0010
 IC Label P/N 3000588-0010
 IC Bezel P/N 3000586
 Assembly, Size D Message Bezel with Enclosed Seats Warning Label

TAG 037



Sutphen Tag 38
IC Assembly P/N 3000587-0019
IC Label P/N 3000588-0019
IC Bezel P/N 3000586
Assembly, Size D Message Bezel with
Fumes Caution Label

TAG 038



Sutphen Tag 38-1-A
IC Assembly P/N 3000587-0106
IC Label P/N 3000588-0106
IC Bezel P/N 3000586
Assembly, Size D Message Bezel with
Horizontal Fumes Caution Label

TAG 038-1

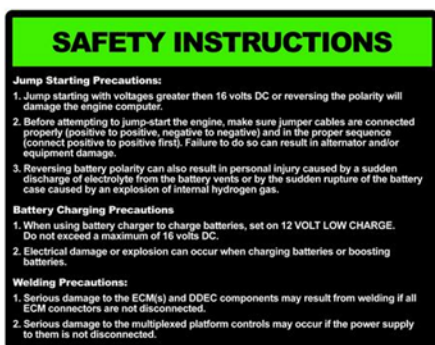

Sutphen Tag 55-A
IC Label P/N 3001029-0001
Battery Safety Precautions Label

TAG 055



Sutphen Tag 56-A
IC Assembly P/N 3000587-0008
IC Label P/N 3000588-0008
IC Bezel P/N 3000586
Assembly, Size D Message Bezel with
Explosion Warning Label

TAG 056



Sutphen Tag 57-A
IC Assembly P/N 3000587-0001
IC Label P/N 3000588-0001
IC Bezel P/N 3000586
Assembly, Size D Message Bezel with
Seated and Belted Warning Label

TAG 057A



Sutphen Tag 58
IC Assembly P/N 3000587-0012
IC Label P/N 3000588-0012
IC Bezel P/N 3000586
Assembly, Size D Message Bezel with
Traction Warning Label

TAG 058

Operator Manual



Sutphen Tag 59-A
 IC Assembly P/N 3000587-0006
 IC Label P/N 3000588-0006
 IC Bezel P/N 3000586
 Assembly, Size D Message Bezel with Fan Warning Label

TAG 059



Sutphen Tag 60-A
 IC Assembly P/N 3000587-0007
 IC Label P/N 3000588-0007
 IC Bezel P/N 3000586
 Assembly, Size D Message Bezel with Close Crosslay Cover Warning Label

TAG 060



Sutphen Tag 66-A
 IC Assembly P/N 3000587-0003
 IC Label P/N 3000588-0003
 IC Bezel P/N 3000586
 Assembly, Size D Message Bezel with Stand Clear of Outrigger Warning Label

TAG 066

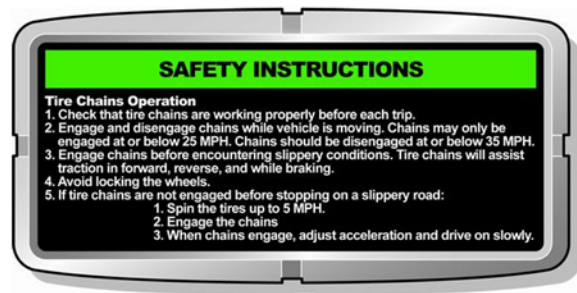

Sutphen Tag No. 281
 IC Assembly P/N 3000573-0002
 IC Label P/N 3000575-0002
 IC Bezel P/N 3000574
 Assembly, Size B Message Bezel with Tire Chains Instruction Label

TAG 281



Sutphen Tag 282
 IC Label P/N 3001037-0001
 Stabilizer Interlock System Label

TAG 282

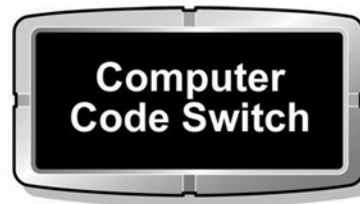

Sutphen Tag 310
 IC Assembly P/N 3000582-0003
 IC Label P/N 3000584-0003
 IC Bezel P/N 3000583
 Assembly, Size C Message Bezel with Computer Code Switch Label

TAG 310



Sutphen Tag 322-A
IC Assembly P/N 3000587-0004
IC Label P/N 3000588-0004
IC Bezel P/N 3000586
Assembly, Size D Message Bezel with Lowering Cab Warning Label

TAG 322



Sutphen Tag 323A
IC Assembly P/N 3000573-0001
IC Label P/N 3000575-0001
IC Bezel P/N 3000574
Assembly, Size B Message Bezel with Cab Safety Precautions Label

TAG 323A



Sutphen Tag 324
IC Assembly P/N 3000582-0001
IC Label P/N 3000584-0001
IC Bezel P/N 3000583
Assembly, Size C Message Bezel with Cab Tilt Label

TAG 324



Sutphen Tag 325-A
IC Assembly P/N 3000582-0004
IC Label P/N 3000584-0004
IC Bezel P/N 3000583
Assembly, Size C Message Bezel with Cab Tilt Latch Label

TAG 325



Sutphen Tag 326-A
IC Label P/N 3001033-0001
Aerial Rappel Warning Label
50% Scale

TAG 326



Sutphen Tag 327
IC Assembly P/N 3000587-0031
IC Label P/N 3000588-0031
IC Bezel P/N 3000586
Assembly, Size D Message Bezel with Leveling Override Instruction Label

TAG 327

Operator Manual



Sutphen Tag 328
 IC Assembly P/N 3000587-0028
 IC Label P/N 3000588-0028
 IC Bezel P/N 3000586
 Assembly, Size D Message Bezel with
 Open Valves Fall Hazard Danger Label

TAG 328



Sutphen Tag 365
 IC Assembly P/N 3000587-0016
 IC Label P/N 3000588-0016
 IC Bezel P/N 3000586
 Assembly, Size D Message Bezel with
 Vehicle Capacity and Height Warning Label

TAG 365

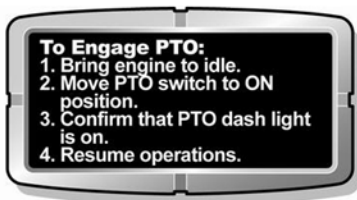

Sutphen Tag 368
 IC Assembly P/N 3000582-0005
 IC Label P/N 3000584-0005
 IC Bezel P/N 3000583
 Assembly, Size C Message Bezel with
 Engage PTO Instruction Label

TAG 368



Sutphen Tag 370
 IC Label P/N 3001036-0001
 Platform Equipment Label

TAG 370



Sutphen Tag 371
 IC Assembly P/N 3000587-0049
 IC Label P/N 3000588-0049
 IC Bezel P/N 3000586
 Assembly, Size D Message Bezel with
 Drain Yoke Caution Label

TAG 371



Sutphen Tag 375
 IC Assembly P/N 3000587-0024
 IC Label P/N 3000588-0024
 IC Bezel P/N 3000586
 Assembly, Size D Message Bezel with
 Set Rear Jacks Caution Label

TAG 375

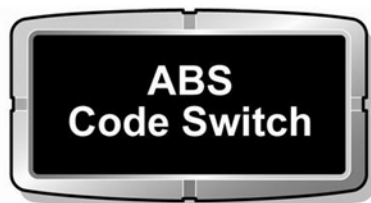

Sutphen Tag 381 -A
IC Assembly P/N 3000582-0002
IC Label P/N 3000584-0002
IC Bezel P/N 3000583
Assembly, Size C Message Bezel with
ABS Code Switch Label

TAG 381



Sutphen Tag 382
IC Assembly P/N 3000587-0009
IC Label P/N 3000588-0009
IC Bezel P/N 3000586
Assembly, Size D Message Bezel with
Pressurized Inlets Warning Label

TAG 382



Sutphen Tag 385
IC Label P/N 3001294-0001
Jump Stud Label
50% Scale

TAG 385



Sutphen Tag 395-C
IC Assembly P/N 3000587-0020
IC Label P/N 3000588-0020
IC Bezel P/N 3000586
Assembly, Size D Message Bezel with
Pump Overheat Procedure Label

TAG 395C



Sutphen Tag 405-A
IC Label P/N 3001033-0002
Power Line Danger Label
50% Scale

TAG 405

UP	RET	RET	RET	RET	UP	UP	UP
Front Axle Lock	Left Front Stabilizer	Left Rear Stabilizer	Right Front Stabilizer	Right Rear Stabilizer	Right Stabilizer	Left Stabilizer	Rear Stabilizer
DOWN	EXT	EXT	EXT	EXT	DOWN	DOWN	DOWN

Sutphen Tag 406-A
IC Label P/N 3001035-0001
Manual Override Outrigger Controls Label
50% Scale

TAG 406

Operator Manual



Sutphen Tag 407-B
IC Assembly P/N 3000587-0011
IC Label P/N 3000588-0011
IC Bezel P/N 3000586
Assembly, Size D Message Bezel with
Turntable Area Instruction Label

TAG 407B



Sutphen Tag 408-B
IC Label P/N 3001034-0001
Down to Lock Label

TAG 408B



Sutphen Tag 410-A
IC Assembly P/N 3000587-0013
IC Label P/N 3000588-0013
IC Bezel P/N 3000586
Assembly, Size D Message Bezel with
Do Not Walk Warning Label

TAG 410



Sutphen Tag No. 410-B
IC P/N 3001030-0001
Exiting Cab Caution Label

TAG 410B



Sutphen Tag 416-B
IC Assembly P/N 3000587-0005
IC Label P/N 3000588-0005
IC Bezel P/N 3000586
Assembly, Size D Message Bezel with
Safety Chain Fastened Warning Label

TAG 416

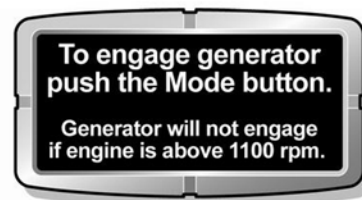

Sutphen Tag 417-A
IC Assembly P/N 3000582-0006
IC Label P/N 3000584-0006
IC Bezel P/N 3000583
Assembly, Size C Message Bezel with
Engage Generator Instruction Label

TAG 417



Sutphen Tag 427-B
 IC Assembly P/N 3000587-0034
 IC Label P/N 3000588-0034
 IC Bezel P/N 3000586
 Assembly, Size D Message Bezel with Bumper Warning Label

TAG 427B

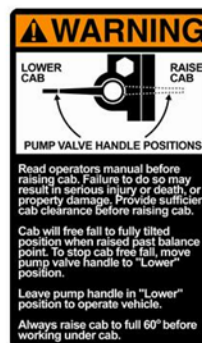

Sutphen Tag 428
 IC Label P/N 3001031-0001
 Pump Valve Handle Warning Label

TAG 428

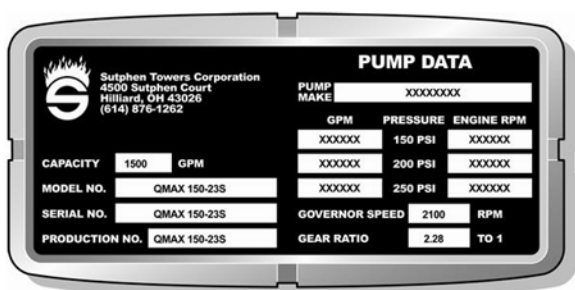

IC Assembly P/N 3000576-0001-SUTT
 IC Label P/N 3000578-0001-SUTT
 IC Bezel P/N 3000577
 Assembly, Size A Message Bezel with Sutphen Towers Pump Data Label

TAG 430



Sutphen Tag 431
 IC Label P/N 3001026-0001
 Chassis Data Label

TAG 431

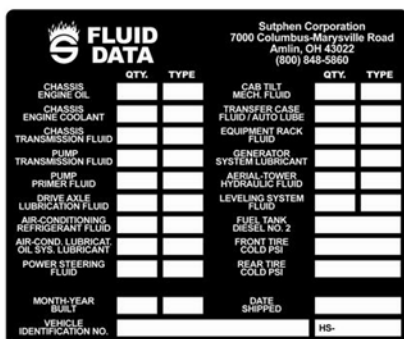

Sutphen Tag 432
 IC Label P/N 3001027-0001
 Fluid Data Label

TAG 432

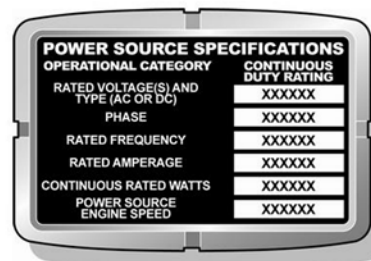

Sutphen Tag 433
 IC Assembly P/N 3000587-0044
 IC Label P/N 3000588-0044
 IC Bezel P/N 3000586
 Assembly, Size D Message Bezel with Power Source Specs. Label

TAG 433

Operator Manual

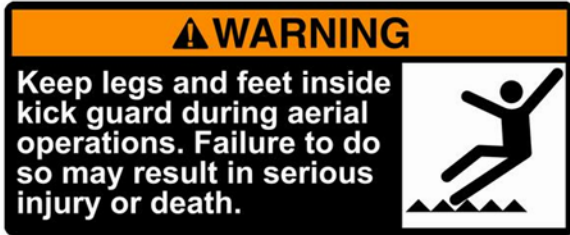

Sutphen Tag 434-B
IC Label P/N 3001658
Keep Legs Inside Kick Guard Warning Label

TAG 434B



Sutphen Tag 435 A
IC Assembly P/N 3000582-0017
IC Label P/N 3000584-0017
IC Bezel P/N 3000583
Assembly, Size C Message Bezel with Auto-Pump Compressor Drain Label

TAG 435



Sutphen Tag 436-B
IC Assembly P/N 3000587-0102
IC Label P/N 3000588-0102
IC Bezel P/N 3000586
Assembly, Size D Message Bezel with Front Suction Elbow Caution Label

TAG 436B



Sutphen Tag 437
IC Assembly P/N 3000582-0018
IC Label P/N 3000584-0018
IC Bezel P/N 3000583
Assembly, Size C Message Bezel with Ladder Rack Up/Down Label

TAG 437



Sutphen Tag 438
IC Assembly P/N 3000587-0103
IC Label P/N 3000588-0104
IC Bezel P/N 3000586
Assembly, Size D Message Bezel with Waterway Valve Override Label

TAG 438



Sutphen Tag 440
IC Assembly P/N 3000587-0104
IC Label P/N 3000588-0104
IC Bezel P/N 3000586
Assembly, Size D Message Bezel with Equipment Weight Limit Label

TAG 440



UP Front Axle Lock DOWN	RET Right Front Stabilizer EXT	RET Left Front Stabilizer EXT	UP Right Stabilizer DOWN	UP Left Stabilizer DOWN	UP Rear Stabilizer DOWN
----------------------------------	---	--	-----------------------------------	----------------------------------	----------------------------------

Sutphen Tag No. 441
IC Label P/N 3001397-0001
Manual Override Outrigger Controls Label (SPH)
50% Scale



Sutphen Tag 442-B
IC Label P/N 3001932-0002
Lifting Eye Warning Label

TAG 441

TAG 442B



Sutphen Tag 446
IC Label P/N 3001434-0001
Lifting Eye Capacity Label

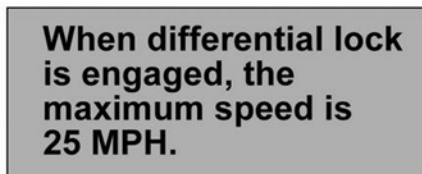

Sutphen Tag 448
IC Label P/N 300584-0018
Differential Lock Engagement Label

TAG 446

TAG 448



Sutphen Tag 449-B
IC Assembly P/N 3000582-0021
IC Label P/N 3000584-0021
IC Bezel P/N 3000583
Assembly, Size C Message Bezel with
Water Tank Refill Caution Label



Sutphen Tag 450-B
IC Assembly P/N 3000587-0110
IC Label P/N 3000588-0110
IC Bezel P/N 3000586
Assembly, Size D Message Bezel with
Pressure Governor RPM Warning Label

TAG 449B

TAG 450B

▽ *Operator Manual*



Sutphen Tag 452-A
IC P/N 3001514-0001
Generator PTO Label

TAG 452



Sutphen Tag 454-B
IC Assembly P/N 3001499-0016
IC Label P/N 3001497-0016
IC Bezel P/N 3001469
Assembly, Size E Message Bezel with
Generator Wattage Caution Label

TAG 454B



Sutphen Tag No. 455-A
IC Label P/N 3001525-0001
Ladder Belt Tie-Off Point Warning Label

TAG 455



Sutphen Tag CHT-499
IC Label P/N 3001431-0001
Sutphen Logo Label

TAG 499



1.6 Cab Setup Procedures

Locating the Vehicle

1. Make sure apparatus is on firm pavement, and that it is clear of overhead obstacles, such as poles, trees, wires, building overhang, etc.
2. Make sure that the stabilizers are not going to sit upon manhole covers, drains, or grates in the street or on sidewalks.
3. Good judgment must be used in locating the apparatus at the fire scene. Ideal conditions may not always exist, so caution must be used to determine as safe a location as possible for the apparatus.
4. Spot the rig about 20 feet from the building when possible. This will give you maximum vertical coverage of the building.
5. Set the parking brake.
6. Place the transmission in neutral.

Activating the Hydraulic System

There is a PTO (Power Take-Off) which operates the hydraulic pump, providing hydraulic pressure to the system.



CAUTION

An electric switch located near the center of the cab dash panel activates the PTO. A pilot light will come on when the PTO switch is moved to the “on” position.



CAUTION

Attempting to place the PTO in gear with the pump in gear will result in serious damage to the PTO and transmission—unless engine speed is at an idle of approximately 700 RPM’s.

1. Engine must be at idle RPM.
2. Be sure there is at least 90 lbs. of air pressure on the truck air system.
3. The truck must be at complete stop, parking brake set, and transmission in neutral (N).
4. Move PTO switch on dash to “on” position. (Wait about 2 seconds.)

The cab controls are now set to operate the hydraulic system.



1.7 Cab Setup for Fire Pump Operation

NOTE: See Fire Pump Manual for more detailed information.

1. The truck must be stopped and parking brake set.
2. Truck transmission must be in neutral (N) position.
3. Engine must be at idle RPM.
4. Move the pump shift lever from ROAD position to PUMP position. Do this by pulling back on the lever. At the same time the pump shift is activated, the lock-up for the automatic transmission is also engaged. The pump shift lever holds the transmission in the pumping gear position.



Air Pump Shift



Electronic Pump Shift

Pump Shift Lever

5. (Only if the pump is wet)

Shift transmission to drive (D) (1-4) position. Power from the engine is now being transferred to the pump drive gear. Observe the second illuminated green OK TO PUMP indicator light next to the shift lever. The lock-up for the automatic transmission will be engaged when the transmission is shifted into drive (D). The pump shift lever will hold the transmission in the pumping gear position.

If the light is not on, the pump is not engaged. Repeat steps 1-5 and observe for pump engagement.

6. To have the pump ready for operation later, leave transmission selector in neutral (N). For pump operation, simply put transmission selector in drive (D) (1-4).

NOTE: Upon arrival at a structure fire or other incident where the tower is not immediately needed, but the fire pump is being used, it is a good practice to place the PTO in gear before placing the fire pump in gear. Should a need to use the tower arise, and the fire pump is being used, the stabilizers are set, and the tower is then ready for immediate use. If the PTO was not engaged before the pump was set up, it would be necessary to slow the engine to an idle to engage the PTO, jeopardizing fire fighting operations.

1.8 Setup for Simultaneous Aerial and Pump Operations

1. Follow steps for placing PTO in gear on page 1-22.
2. Follow Aerial Tower setup instructions on page 1-26.
3. Leave transmission selector in “neutral” for the pump to be ready to operate without churning.
4. Repeat steps 4 through 6 for placing pump in gear.

NOTE: When arriving at a structure fire or on occasion where the tower is not immediately needed, but the fire pump is being used, place the PTO in gear and deploy the ground stabilizer before placing the fire pump in gear. Then, if the need to use the tower arises while the fire pump is being used, the stabilizers can be set, and the tower will be ready for immediate use. If the PTO is not engaged before the pump is set up, then slow the engine to idle before engaging PTO.



CAUTION

Attempting to place the PTO in gear with the pump in gear will result in serious damage to the PTO and transmission—unless engine speed is at an idle of approximately 700 RPM's.



1.9 Aerial Setup Procedures



DANGER

Always set up the apparatus on concrete, blacktop, or gravel. Surface must be firm and solid. Soil/ground surfaces are not desirable, as the outrigger may sink into the ground causing a tip over. Soil surfaces that seem stable upon setup may erode with fire scene runoff water, thus making them unstable. Asphalt parking lot surfaces are typically thin and in hot weather may allow the outrigger to sink through, especially if the subsurface material is sand.





DANGER

Power lines should always be observed and always avoided.



WARNING

The aerial device is rated for service in winds up to 35 mph. 

1. Leave transmission in neutral.
2. Set parking brake.
3. Engage PTO at engine idle.
4. Exit Cab
5. Check inclinometer and verify the truck is level within the safe operating range. 
6. Place the wheel chocks approximately 3” in front of and behind the rear tires.
7. Locate stabilizer controls at each side of rear of the truck. 
8. Verify adequate clearance on both sides for jack extension.
9. Locate stabilizer controls at each side of the rear of the truck.
10. Extend jacks fully outward on both sides using the out arrows.
11. Place the ground pads under the stabilizer feet.
12. Lower the stabilizers on both sides using the down arrows, lift the weight of the vehicle off the suspension/tires.
13. Level the vehicle from side to side. Note level indicators.



Operator Manual



WARNING

Exercise caution when extending the stabilizers, taking care to watch it closely as it is extended. Personal injury or damage to property and/or the stabilizer may occur if the stabilizer is deployed improperly.



WARNING

Never operate the ladder without first deploying the stabilizer jacks with proper ground pads beneath them.

1.10 Safety Pins

13. Insert safety pins into their appropriate holes. (see Figure 2)

NOTE: Always install safety pins on stabilizers. In the event of a hydraulic failure, they may be necessary to prevent the apparatus from becoming unstable and collapsing.

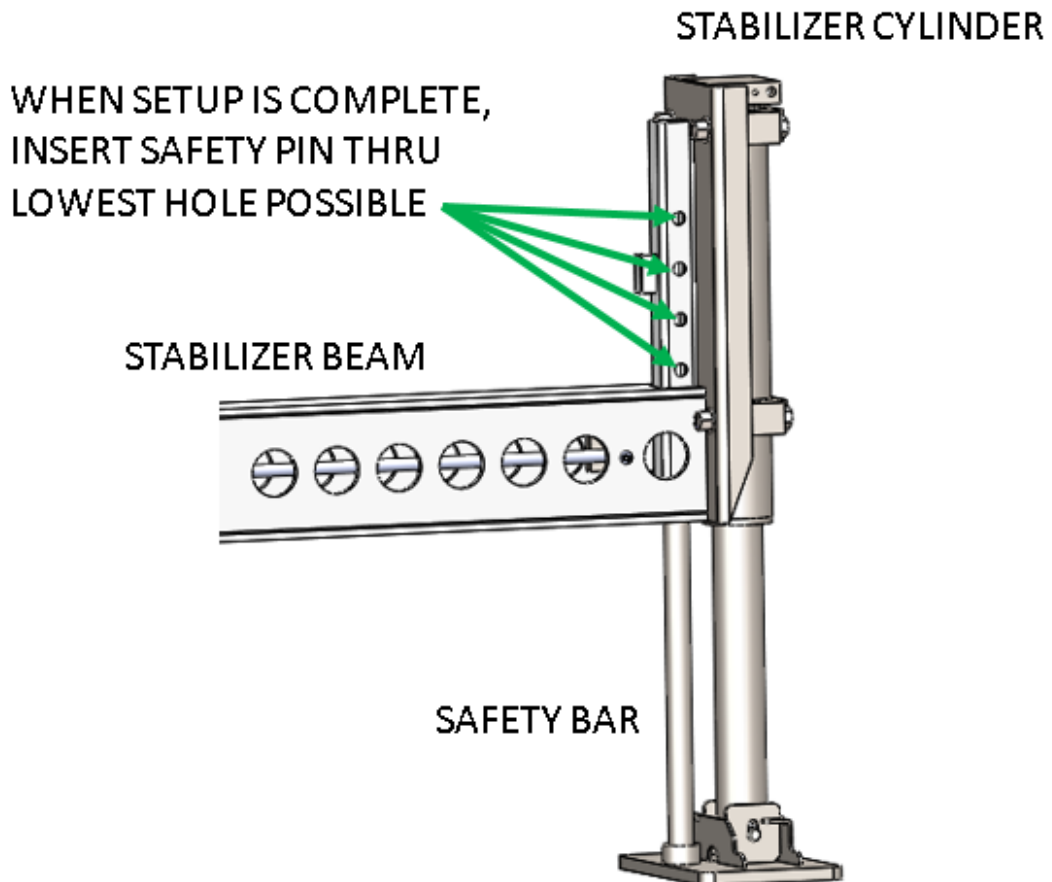

Figure 2



NOTE: When all prerequisites of the interlock have been met, the audible alarm will stop sounding. If the alarm does not silence, the interlock will not allow operation of the aerial. The interlock requires that:

- A. The main stabilizers are fully extended.**
- B. The safety pins are in place**
- C. The rear stabilizers have taken enough weight off the suspension to activate the pressure switch.**

1.11 Upper Power

14. Turn on the “UPPER POWER” switch. This energizes the controls at the ladder pedestal. Ladder intercom will also become active.
15. The "UPPER POWER" switch controls lighting, intercom and rung alignment light.
16. Verify with all personnel that the tower is ready to operate. When stabilizers and ground pads are properly set on stable ground, the tower is designed to operate at optimum operational height and horizontal reach with rated payload. Always operate the tower with caution so it does not strike the cab or any other portion of the truck.



▽ **Operator Manual**

1.12 Short Jacking

One of the two stabilizers must be fully extended and lowered.
The short side must only be deployed and lowered.
Safety pins must be inserted.

There are two momentary “Interlock Over-Ride” buttons on the truck.
One on the control pedestal and one at the left rear control panel.

To move the ladder in the Short Jack configuration, both “Interlock Over-Ride” buttons must be pressed and held until the ladder is lifted from the cradle.

Once the ladder is out of the cradle, the envelope controls will take over and the “Interlock Over-Ride” buttons can be released.

In the Short Jack configuration, the ladder can only rotate to the side with the fully extended stabilizer. The screen on the pedestal will display the allowable ladder positioning.

Returning the ladder to the cradle position will reset the “Interlock Over-Ride” and the Short Jack operation.





1.13 Ladder Function Controls

NOTE: The aerial ladder must be operated with respect, discretion, and proper training. The aerial ladder should move on low speed when there is any danger; such as power transmission lines, buildings, during close operations, returning to the cradle, and during operation around the apparatus cab or body.

All of the aerial ladder function controls have been designed to be operated intuitively. The fully manual hydraulic valve body provides a precise, "manual" feel. If the control handle is moved slightly or slowly, the ladder responds with a similarly slight reaction.

The pedestal contains all of the controls required to operate the aerial ladder. (see Figure 3)



Figure 3
Ladder Controls At Pedestal

Elevation

Raise the ladder by pulling the right control lever toward you.

Lower the ladder by pushing the right control lever away from you.

The ladder can be elevated from minus 5 degrees to plus 75 degrees from the horizontal while in any position given that no obstructions, such as the body or cab, are present.

NOTE: When moving the ladder from the cradle, the first motion of the ladder should be "RAISE". This should continue until the ladder is well above the apparatus.



DANGER

When raising the ladder, extreme caution must be used near power lines. The operator must observe the ladder structure from base to tip to make sure the ladder is clear.



WARNING

This Aerial Device is rated for service in winds up to 35 mph.



Extend/Retract

Extend the ladder by pushing the left control lever away from you.

Retract the ladder by pulling the left control lever toward you.



WARNING

Before retracting the ladder, make sure the waterway drain is open to avoid pressurizing the water in the waterway. Failure to do so can result in serious damage to the waterway. (See section on "Draining of Waterway and Nozzle").



Rotation

Rotate the ladder clockwise by pushing the center control lever away from you.

Rotate the ladder counter-clockwise by pulling the center control lever toward you.

The ladder can rotate a continuous 360 degrees either to the left or to the right. It is recommended that the engine be at idle when rotating.



WARNING

While rotating the ladder, the operator should not change directions before the ladder comes to a complete stop! If the operator accidentally changes rotation direction with the ladder not coming to a complete stop, a built-in relief valve is provided to reduce shock. However, this can still damage or break the rotation gear. In no way should this be an operational practice!

NOTE: The recommended procedure for ladder operation is a slow, steady movement of the control lever. This will produce a smooth ladder operation. Rapid movement of the control levers will result in rough jerking of the ladder. This will create excessive loading on the ladder structure. This kind of operation is unsafe and will lead to premature wear and possible structure failure.

The hydraulic valve body has built-in relief valves to prevent damage to hydraulic components. If the operator attempts a maneuver that has exceeded the ladder's hydraulic capacity, the ladder will not move. Also, when the function has reached the end of its travel (e.g., the ladder is fully extended), the ladder will stop moving, even if the control handle is not released.

NOTE: Relief valves are incorporated in the system to prevent damage to components from hydraulic pressure build-up. This does not guarantee that damage will not occur to the aerial while it is in motion! Careless operation, overloading the aerial, and collisions with other objects may allow damage to occur even when the relief valves are properly adjusted. The operator is ultimately responsible for the safe operation of this aerial!

High Speed Control



CAUTION

Safe operation must be maintained when using "High Speed".

The "HIGH SPEED" foot switch is located on the turntable floor next to the pedestal. During ladder operations, this switch increases the engine idle speed to a higher, preset level that, in turn, increases the hydraulic system power available to ladder functions. This option is not available when the apparatus is pumping water.

When using "HIGH SPEED", it is very important that the operation of the controls be performed in the proper sequence. By doing so, excessive loads on the ladder structure will be avoided and a smooth and safe operation will result. This sequence is as follows.

1. Actuate the desired function lever.
2. Push the "HIGH SPEED" foot switch to accelerate the function being operated.
3. When the ladder approaches the desired position, release the "HIGH SPEED" switch.
4. Release the function lever at the desired location.

When the aerial is returned to the cradle, remove jack pins. An electro-hydraulic valve will automatically transfer power from the aerial to the jacks, locking out the aerial ladder functions and allowing jack operation.

Auxiliary Hydraulic Power Switch

NOTE: The auxiliary hydraulic power switch is to be used for service purposes only to place the ladder back into cradle and to raise the jacks. It is not to be used for normal operations. Located at back of truck.



The auxiliary hydraulic power switch is located at the back of truck. Use the auxiliary hydraulic power switch if a main hydraulic pump fails in the ladder or if the truck engine fails. The auxiliary power is an electric motor, operating from the truck battery system which operates the auxiliary hydraulic pump.

Operate the motor by activating the momentary auxiliary power switch.

All ladder functions can be operated on auxiliary power.



CAUTION

Prolonged operation of the auxiliary hydraulic motor could cause it to overheat. Operate for no longer than 10 minutes at a time to avoid overheating and burning out the motor. If the motor becomes hot, shut down and allow it to cool. Failure to do so could result in serious damage to the motor.



Additional Pedestal Controls and Indicators

In addition to the ladder function controls, there are other switches and indicators on the pedestal. (See figure 3 on page 1-30) These are described as follows:

Rung Alignment

The rung alignment light indicates the ladder rungs are aligned for climbing.

Panel Light Switch

The panel light illuminates the control panel for nighttime operation.

▽ **Operator Manual**

Alignment Light

The alignment light indicates when the ladder is aligned with the cradle when stowing the ladder after use. This indicator is used in conjunction with the arrows located on the side of the turntable and the compartment top.

1.14 Ladder Positioning

When positioning the ladder for climbing, it is strongly advised that the tip of the ladder **SHOULD NOT BE RESTED ON OR POWERED DOWN ONTO ANY SURFACE** such as a window ledge or roof. The tip should be placed so that, when loaded, it remains several inches above the desired location. (See fig. 4) This ladder is designed to be loaded with the tip unsupported. Remember -- as personnel climb the ladder, the weight will bring the tip nearer to the surface.

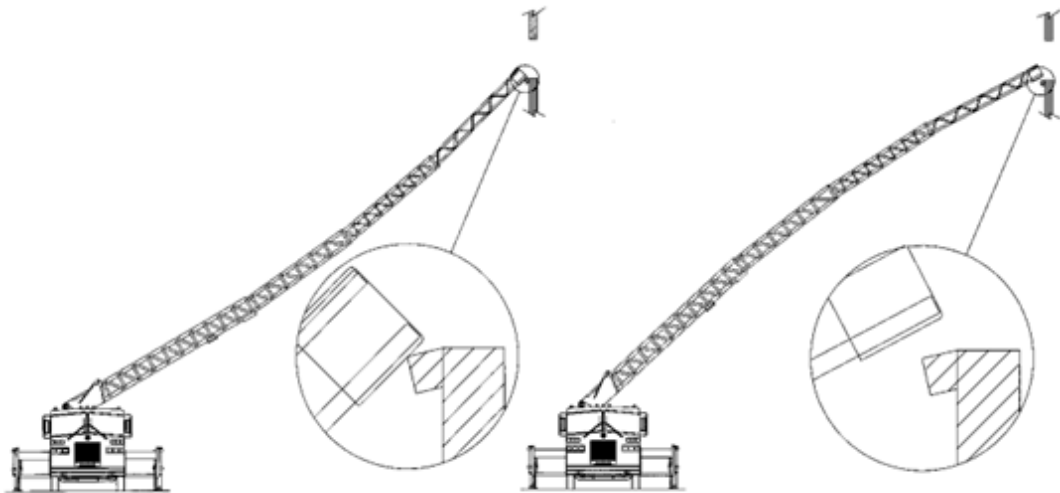

Fig.4 (Ladder Flex Exaggerated For Illustration Clarity)

NOTE: Reverse loading of the aerial device will cause structural damage, especially at full extension and/or near horizontal elevations. This device is designed to be used with the tip unsupported!

1.15 Climbing Ladder or Using as an Escapeway

When climbing the aerial, or when an escape procedure is in progress, the ladder lockout switch should be engaged. This will prevent any accidental movement of the ladder while it is occupied. As an extra precaution, close the cover on the pedestal to render the ladder function controls inaccessible.



1.16 Safety Interlock System

Interlock Jack Release

The safety interlock system prevents ladder operation that could result in personal injury or dangerous conditions. The system contains a locking device that locks the transfer valve in the “LADDER” position when the aerial is raised from its bed. This prevents the jacks from being operated while using the ladder. It also includes an electric/hydraulic valve that disables the ladder controls when the stabilizers are not properly deployed. In addition to the interlock, an audible alarm sounds until the stabilizers are set.

NOTE: The stabilizers must be visually checked by the operator or other designated person to make sure the stabilizers and pads are properly set, and safety pins inserted.

The aerial is now ready for operation. The hydraulic transfer valve should have shifted from jack to aerial position, allowing the controls to operate the aerial ladder. The aerial ladder must move on low speed when there is any danger, electric wires, buildings, at close operations, returning to the cradle, and during operation around the cab.

Return the aerial to the cradle, remove jack pins. The hydraulic circuit will transfer, locking out the aerial ladder functions and allowing jack operation. The aerial ladder must be operated with respect, discretion, and proper training.



WARNING

The stabilizers must be visually checked by the operator or a designated person to make sure the stabilizers and pads are properly set and safety pins inserted.



CAUTION

Never operate the tower unless the stabilizers and pads are properly set.

1.17 Waterway and Nozzle

Operation and Use

The waterway through which water from the pump is transferred to the nozzle is a three section telescopic aluminum device. It is located within the tower first section, mounted and cushioned to eliminate any undue stress or strain under tower operations conditions. Special seals are provided at the attachment location of each waterway section to ensure constant alignment and eliminate wear to the tubes.

The waterway is fed from the pump through the main feed line. This feed line is provided with an electrically controlled, slow closing, 3-inch ball valve. This ensures that no undue water surge is applied to the waterway or pump. Water then comes up through the turntable and passes through a stainless steel flex tube that is directly attached to the waterway.

The feed line for the waterway is provided through a ball valve at the lower entrance of the water supply. This is to make sure no undue water surge is applied to the waterway.

A relief valve is installed in the waterway system to help prevent excessive pressure in the waterway. Should the operator retract the tower without opening the waterway drain, or should pump pressure exceed the capacity of the waterway, the relief valve will open. Do not exceed 250 PSI discharge pressure. The waterway drain should always be left 50% open when tower is not being operated along with all nozzles and valves.

Maintenance is described in the AERIAL TOWER LUBRICATION AND SERVICE section.

NOTE: Before retracting the tower, make sure the nozzle and the waterway drain are open to avoid compressing the water in the waterway. Failure to do so can result in serious damage to the waterway.



Draining the Waterway

1. Close waterway supply valve completely.
2. Open all nozzles and/or valves at fly end of ladder.
3. Open waterway drain valve.
4. Raise ladder to at least 40 degrees.
5. After all water has drained out, go to step #6.
6. Fully extend ladder.
7. Lower ladder off the side of truck at below grade angle.
8. Wait until water has drained completely from nozzles and drains at fly section.
9. Retract ladder and return to cradle.

NOTE: These steps must be followed in the above order to completely drain waterway and all nozzles which must be open 50%. This will prevent freezing the waterway in cold weather and damaging the waterway when retracting.

NOTE: Waterway drain valve at pump panel must be carried in the open position when water tower is not being used.

1.18 Optional Breathing Air System

If a life support breathing system is installed on the aerial. This system has an air cylinder mounted in brackets on the base section of the ladder, a shut-off valve, and a constant flow air regulator.

Air is piped from the regulator by a heavy duty air hose through an air reel, located in the base section of the tower to the tip.

At the ladder tip, there are air connections available to connect fire department breathing air apparatus.

Air to the connections can be regulated from the air supply cylinder by presetting the regulator at approximately 80 PSI. Once the air pressure is regulated, as

required by the operator, turn the air on at the air cylinder valve to provide air to the tip. The air valve should always be turned off when not in use. An air drain valve is provided on the bottom of the filter and should periodically be opened briefly to expel any moisture that may be captured in the filter. Use of the air system should be determined by the personnel using the aerial device.

1.19 Return Aerial to Travel Position

Retract the Tower

Retract the tower fully by pulling the left control lever, located at the control box, toward you.



CAUTION

If the waterway has been used before retracting the tower, the nozzle and waterway drains must be open to avoid compressing the water in the waterway. Allow enough time for the waterway to drain before retracting the tower. Failure to do so can result in serious damage to the waterway.

Rotate the Tower

To rotate the tower to the right (clockwise), push the center control lever, located at the control box, away from you. To rotate the tower to the left (counter-clockwise), pull the control lever toward you. To store the aerial, rotate the tower until it is properly aligned to lower into the cradle.

NOTE: The trucks are equipped with an alignment indicator. This indicator is part of the graphic screen on the pedestal. It will light when the tower is in position to come down directly in the middle of the support cradle.

Aerial towers are also equipped with alignment arrows. One arrow is affixed to the turntable and the other arrow is affixed to the tread plate deck. They are located at the outer rim of the turntable, adjacent to the control station.

Rotate the tower until the points of both arrows align. The tower is now in position to lower into the support cradle.



Lower the Tower

NOTE: This function should only be performed with the engine speed at idle.

Lower the ladder fully by pushing the right control lever away from you. After the tower is lowered into the cradle, continue to hold the control lever in the lower position for a few seconds. This will pressurize the lift cylinders in the “down” direction. The holding valves in the cylinders will maintain this pressure, effectively locking the ladder in the cradle for travel.

Turn off “UPPER POWER”

Remove Wheel Chocks

NOTE: Always remove the wheel chocks before releasing the stabilizers.

Failure to do so could result in wedging the chocks tightly against the tires making them un-removable. Remove safety pins on stabilizers.

Retract the Stabilizers

1. Remove jack pins and stow in their holders just behind the front stabilizer cylinders.
2. Move to the lower operator’s position for the hydraulic system.
3. Raise the rear stabilizers completely, by pushing the “UP ARROW BUTTON”.

NOTE: Do not unload one stabilizer before the other. This imparts strong twisting loads on the apparatus, which could cause damage.

Retract the main stabilizers completely by pushing “ARROW BUTTON” pointing to the center of the truck.



WARNING

Exercise caution when retracting the opposite side stabilizer, taking care to watch it closely as it is retracted. Always use a spotter when available!

Operator Manual

4. Return the ground pads to their stowages.
5. Make sure engine is at idle R.P.M.
6. Enter the cab.
7. Move the PTO switch from "IN" to "OUT" position. Make sure the red PTO indicator light goes out.
8. Enter the cab and disengage the fire pump, if used.
9. Shift transmission to neutral.
10. Wait until speedometer registers "0" miles per hour.
11. Pause for three seconds.
12. Move pump shift lever from "pump" position to "road" position.
13. Disengage the PTO switch from "in" to "out" position. Make sure the red pilot light goes out.
14. Release the parking brake.
15. Place transmission in appropriate gear (Drive 1-4 or Reverse).



CAUTION

Before driving away, the operator should make a quick inspection around the truck to make sure all tools and appliances have been removed and stowed, compartment doors closed, and the vehicle is unobstructed.

Operator must also check the four (4) warning lights above the windshield marked "Upper Power", "Jacks Down", "Cab Door Open", and "Compartment Open" to make sure they are not lighted.



WARNING

All personnel must be seated and seat belts fastened before unit is moved.



WARNING

Never back the truck unless a guide has been placed at the rear of the truck, giving clear signals to the operator. If the guide disappears from view, the movement must be stopped until the guide appears.

Chapter 2 Maintenance Manual

		<u>Page</u>
2.1	Aerial Maintenance	2-2
	<i>Stabilizers</i>	2-2
	<i>Main Lift Cylinders</i>	2-2
	<i>Pivot Shaft Bearings</i>	2-2
	<i>Turntable Bearing</i>	2-2
	<i>Rotation Gear Reducer</i>	2-3
	<i>Drive Gears</i>	2-4
	<i>Sheaves and Cables</i>	2-4
2.2	Extension System.....	2-4
	<i>Cable Adjustment Procedure</i>	2-4
	<i>Slide Blocks</i>	2-7
	<i>Waterway and Seals</i>	2-8
2.3	Water Lubrication Procedure.....	2-9
	<i>Waterway Nozzle</i>	2-9
	<i>Hydraulic Oil Tank</i>	2-9
	<i>Hydraulic Tank Fill Instructions</i>	2-11
2.4	High Pressure Filtration System.....	2-13
2.5	Maintenance of Structure.....	2-13
	<i>Aluminum Tower Structure</i>	2-13
	<i>Turntable Attachments</i>	2-14
	<i>Attachment of Support Structure to Truck Frame</i>	2-15
	<i>Aerial Tower and Ice Build Up</i>	2-15
	<i>Aerial Tower Lubrication and Maintenance Schedule</i>	2-17
	<i>Torque Specifications</i>	2-20
	<i>Walk Around Checks for Mobile Fire Apparatus</i>	2-21
	<i>Draining & Winterizing Trucks</i>	2-25



2.1 Aerial Maintenance

Stabilizers

When the stabilizers are extended completely to the ground, an area of the inner sleeve becomes exposed. This exposed area also comes in contact with the inside surface of the outer tube. This area should be periodically coated with a light film of grease. Visually check jack locks. Lubricate grease fittings on each jack cylinder with Pro-One EP-2 Grease, and air lock cylinders with air lubrication oil.

Main Lift Cylinders

The main lift cylinders are located on each side of the main base section of the tower assembly. Each cylinder has two (2) lube points. One (1) lube point is on the rod end where the rod eye attaches to the side plate of the tower assembly. One (1) lube point is on the bottom end where the cylinder is attached to the turntable. At each point, a grease fitting is installed. These points should be lubricated with Pro-One EP-2 Grease every 25 hours of operation, or annually, whichever comes first.

Pivot Shaft Bearings

There are two (2) pivot shaft bearings located on top of the upper assembly side plates, one on each side, which rotate on the pivot shaft. The pivot shaft is permanently attached to turntable side plates on the outside of the side plates. Grease fittings are installed on the pivot shaft bearings. These bearings need to be lubricated with Pro-One EP-2 Grease every 25 hours of operation, or annually, whichever comes first.

Turntable Bearing

The bearing and drive gear assembly are located directly under the turntable. The entire turntable and tower assembly rotates on this bearing. This bearing is pre-lubricated at the factory with a Pro-One EP2 Grease. Grease fittings are provided on the inside of the bearing accessible

through the top of the upper assembly. Lubrication should be done three (3) months after delivery, then annually. Use Pro-One EP-2 Grease.

NOTE: At this time, we recommend all bolts attaching the turntable to the bearing, and all bolts attaching the bearing to the mainframe (where applicable) be checked for tightness.

Rotation Gear Reducer

This device rotates the turntable and tower assembly. It is attached to the lower assembly, below the gear, on the left side of the assembly.

It is driven by a hydraulic motor, directly attached to the high-speed worm gear shaft. No lubrication is required for the hydraulic motor. On the main gear case, there are three (3) plugs, located on the right-handout board side. The top plug is the oil fill vent plug. The one on the side is the fill level plug. The bottom one is the drain plug.

Under normal tower operation conditions, the lube oil in this gear reducer needs to be changed three (3) months after the delivery date of the tower. Thereafter, lube oil needs to be changed every 12 months (average 4 hours per day operation). Never over fill the unit. Check oil level every three (3) months. Use a good grade of 140 weight gear lube oil. At the upper portion of the main gear case, there is a grease fitting. This fitting needs to be greased every 25 hours of operations, or annually, with Pro-One EP-2 Grease.

There are three (3) plugs on the primary rotation gear housing. The one on top (1/4") is the filler-breather plug. The one on the side (1/4") is the lube level plug. The one in the bottom of the high-speed gear housing (1/4") is the drain plug.

Maintain oil level to Oil Level plug. Check oil level every three (3) months. Use a good grade of 140 weight gear lube oil.

NOTE: Access to the rotation gear reducer is gained by removing the access panels adjacent to the turntable access ladder.



Drive Gears

The drive pinion gear and the turntable bearing gear are lubricated with a special elastic lube, designed to endure the life of the unit.

Sheaves and Cables

There are sheaves and cables which are part of the ladder extension/retraction system from the second section up. Each sheave has a bearing and requires periodic lubrication. In the sheave bearing pin, there is a grease fitting provided. Each sheave needs to be greased every 25 hours of service, or annually. A high grade chassis grease, designed for heavy duty service, is recommended.

When servicing the cables, the tower should be extended horizontally to maximum position, and the cables wiped free of any dirt and/or grime with a slightly moist naphtha cloth with ATF. The cables then need lubricated with a thin film of Vitalife 400 or Chain Mate. 



DANGER

Stabilizers must be set before performing this operation.



DANGER

If any strand of the cable is fractured or damaged, immediately lower the aerial and retract slowly. Remove from service until repaired.

2.2 Extension System

Cable Adjustment Procedure

Before beginning cable adjustment, be aware that this adjustment not only affects the tension of the cables, but also the position of the ladder section rungs. Follow the steps outlined below to maintain rung alignment throughout all sections as the cables are adjusted..



1. Set up aerial device according to the operator's manual. Make sure the waterway is empty and there is no extra weight on the aerial.
2. When the rung alignment indicator is illuminated, these rungs will always be aligned. Higher aerial sections, however, rely on proper cable adjustment to maintain alignment.
3. Raise the aerial to 45 degrees, and rotate to one side of the apparatus. Position the aerial at, or slightly above zero degrees, so the cables below rung level can be serviced from the ground. With the aerial fully retracted, measure the gaps between each aerial section. The gap between Sections 1 and 2 is set by the cylinder connection and cannot be adjusted. Make sure there is a gap of 5 ½”– 6 ¼” between sections two and three. If you do not have the required spacing, then make the following adjustments.
 - a. Fully extend the aerial. Be sure the aerial tip does not touch the ground.
 - b. Measure the distance between sections 2-3. It should be 216 inches (+/-1/2) for model SLR75.
 - i. If it is less than 215 ½”- Loosen the retract cables. To loosen the cables you must first loosen the cable rod lock nut, and then loosen the adjustment nut. Retract the aerial approximately 12 inches to release tension from the extend cables. Tighten the extend cables. Repeat this process as necessary to achieve the prescribed dimension on all sections. Re-tighten all lock nuts, then fully retract the ladder and re-check the spacing between the sections.
 - c. Once the proper spacing is achieved, proceed with the adjustment procedure.
4. Assure the aerial slide areas and the waterway are clean and well-lubricated.
5. Inspect all cables for kinks, wear, and any signs of damage. Lubricate cables and sheaves. Extend and retract ladder as needed to reach all components.
6. Fully extend ladder, keeping the tip clear of the ground. Make a mark on the 2nd ladder section, 24 inches from the base section. Retract the ladder 24 inches, until the mark is at the edge of the base section.



7. Measure to the center of exposed length of the 2nd section approximately 93 inches from the base section and make a mark. At this mark, measure the distance from the bottom of the aerial section to the top of each cable. The measurement should be taken with the cable hanging free, without pulling down on it. Both measurements should be $15/16$ inch ($\pm 1/8$ inch), and the pair should be equal. If not, adjust the cables as follows.
 - a. Loosen the cable rod locknut and tighten or loosen the adjusting nuts, retighten the locknut. With the lock nut re-secured, if more than 2" of cable rod end is exposed, contact the factory service department before proceeding.

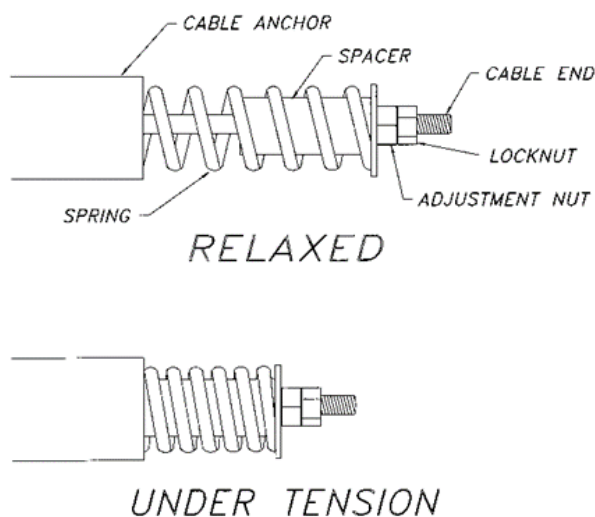

8. Operate the ladder throughout the extend and retract strokes. (Remember there will always be some slack in the cables not doing the work of the function performed. i.e., there will be slack in the retract cables when extending the ladder.)
9. Stop the ladder when the rung alignment indicator illuminates. Check the position of the third ladder section rung alignment. If the third section rungs are running behind the second section rungs, the third section retract cables should be loosened and extend cables (which hang below the second aerial section) tightened. Adjust as necessary.

10. When adjustment is complete, operate the ladder throughout the extend and retract strokes at different angles of elevation
 - a. It is important to remember there will always be a certain amount of slack in the cables, not pulling the ladder sections. At high angles of elevation, the extend cables will always have tension, even while retracting the ladder.
 - b. The ladder sections should move smoothly, with all sections moving simultaneously. Sections should not drift back when the ladder is elevated, beyond the compression of the tensioning springs. At no time should the sections collide while retracting.
11. With the aerial fully retracted, recheck spacing gaps between sections.

Slide Blocks

These devices are attached to the ends of the ladder at both the upper and lower positions on each section. There are 16 slide blocks in the ladder. They support each section of the ladder so no metal-to-metal contact occurs.

The material is UHMW-PE (ultra-high molecular weight polyethylene) compound. It is designed to withstand heavy loading. Lubrication is required in the path in which the slide blocks travel on each section. The slide block paths are lubricated at the factory with Pro-One EP-2 Grease. The slide block path lubrication needs to be checked every 25 hours of eration, or annually.

There are exceptions to this schedule that should be considered. Should the tower be operated at a fire and exposed to excessive dirt and grime, it is recommended that the slide block travel paths be cleaned, and the lubricant be reapplied.



Waterway and Seals

This is the telescopic tube device inside the tower which carries the water to the tower nozzle. It has seals which ride on the internal honed surface of the tubes. These seals are made with an impregnated lubricant. In cases when the tower is operated many times without pumping water through the waterway, it is necessary to provide additional lubrication to the seals through the waterway.

The procedure is as follows:



DANGER

Never extend or move the tower in any way while persons are on the tower. The person oiling the waterway should wear a life belt while on the tower.



DANGER

Stabilizers must be set before performing this operation.

This service should be done following any extensive use of the ladder without pumping water, or monthly. The outsides of the tubes are provided with nylon bearing collar assemblies built into the mounting collar of each section. The outside of these tubes should be kept free of dirt and grime to protect the bearing collars.

Should the ladder be used under extremely dirty conditions, the waterway should be wiped off promptly with Naphtha or similar solvent to assure that the surface of the tubes are free of abrasive particles.

2.3 Waterway Lubrication Procedure (Models SL75, SA75 & SP70—black waterways)

1. Set up truck for tower operation.
2. Raise and rotate ladder off the side of truck.
3. Fully extend ladder out.
4. Use a clean towel and wipe off the outer sections of the waterway tubes.
5. Apply DexMerC  Transmission Oil to a clean towel and wipe the oil on the entire length of each waterway tube, except for the main outside large tube.
6. Retract ladder fully and return ladder to cradle.

Waterway Nozzle

NOTE: Refer to Nozzle Manufacturer’s instructions for more detailed information.

The gears must be kept greased at all times. Pro-One EP2grease should be applied to the grease fittings annually. Grease should be applied until visible through the swivel plugs.

Hydraulic Oil Tank

The tank, located in the body, has a capacity of 50 gallons. The hydraulic oil furnished in your aerial ladder hydraulic system is filtered DexMerC  hydraulic oil. Maintain the oil level to the mark on the dipstick attached to the tank cap. Ensure the new hydraulic fluid is filtered to ISO code 22/18/13.



CAUTION

When checking or adding oil, make sure all hydraulic systems are at rest (retracted). Failure to do so will result in overfilling the system.



The hydraulic oil filters should be changed after the first three (3) months of service and changed annually thereafter.

This is done as follows:

1. Shut off oil to filter at tank valve.
2. Remove the filter.
3. Inspect oil in the filter. Do this by using a piece of clear glass, a white cloth or piece of paper, and pouring some of the oil in the filter onto it. This way any dirt, filings, and moisture can be observed.
4. Replace the filter with the appropriate new filter.



CAUTION

There are two filters in the hydraulic system, one located in the reservoir lid (6 micron – MF1003A06HB) (see Figure 10) and one in the high-pressure portion of the system located under the rear of the cab (6 micron – HP1351A10AN) (Figure 11). Each must be replaced in kind. Failure to do so could result in damage to the hydraulic system or cause poor operation of the tower.



Figure 10



Figure 11

5. After replacing the filters, turn the shutoff valves on.
6. Run the hydraulic system for 1 to 2 minutes to circulate oil through the filters.
7. Check the oil level and add oil to the proper level, if required.

NOTE: All hydraulic cylinders and actuators, except cab lift, must be in the retracted position (i.e., travel position).

Hydraulic Tank Fill Instructions

NOTE: Use only clean oil to fill reservoir.

1. Locate the TOFU (Top Off/Filtration Unit) suction hose supplied with the vehicle, the Hydraulic Tank Fill port and the Hydraulic Tank Fill switch (rear of truck).
2. Locate the Fill Level Dip Stick on top of the Hydraulic Fluid Reservoir.
3. Check the current oil level. Proceed only if it is below the full level (line on dipstick). If it is at. Or above the full mark, the system is full. Replace the dipstick and return the cab to the travel position.
4. Remove the rubber Hydraulic Fill Port plug; by pushing in the quick connect block ring, and pulling the plug out of the port.
5. Remove the plug from the inlet side of the suction hose.
6. Insert the quick connect end of the suction hose in to the fill port. (See Figures 14 & 15)



Figure 14



Figure 15



7. Connect or submerge the inlet side of the suction hose to/into a container of  DexMerc hydraulic fluid.
8. Lift the red safety cover over the Hydraulic Tank Fill switch, and move the switch to the up position.
9. Activate the Aux. Motor switch for 30 seconds. This will begin to draw approximately ½ gallon fluid from the container.
10. Check the fluid level in the reservoir.
11. If the fluid level is below the full level, repeat steps 9 and 10. Adjusting the time period as necessary. CAUTION: Do not run the Aux. Motor for more than 10 minutes.
12. When the fluid level reaches the full level (approximately 2” from the top); push the Hydraulic Tank Fill switch red safety cover down. This will turn the switch off.
13. Remove the suction hose from the Hydraulic Tank Fill port, and securely replace the rubber plug.
14. Drain the remaining fluid in the suction hose back into the fluid source, and replace the metal plug.





2.4 High Pressure Filtration System

System is fitted with KFS4596 reservoir assembly:

The return filter is fitted with a By-Pass indicator. Change this filter if the By-Pass indicator is going into the red. This must be observed when the unit is in operation. With the unit fully setup at high idle observe the By-Pass indicator when running retract and lower at the same time at high idle. This is the highest flow rate the filter will see. Otherwise change this filter after the 1st 50 hours of operation and 250 hours thereafter

Replace with MP Filter original equipment element #HP1351A10AN. The KFS4596-C reservoir assembly is fitted with a dipstick. This reservoir is full when all stabilizers and the aerial stowed at 2-3" from the top of the tank. Hydraulic fluid should be replaced every 500 hours of operation or one year of operation, whichever comes first. Ensure the new hydraulic fluid is filtered to ISO code 22/18/13. New oil from the refinery or oil distributor that has not been filtered to this ISO code, it is typically 24/22/20.

2.5 Maintenance of Structure

Aluminum Tower Structure



The tower structure members are #6061-T6 and #6005-T6 aluminum alloy extrusion. This alloy is very resistant to corrosion and requires very little maintenance. Periodic washing with clear water only is recommended. Use mineral spirits for removal of tar, oil, and smoke film. If a brighter appearance is desired, use any quality automotive polish, a mag and aluminum wheel cleaner, or a Scotch-brite pad.



CAUTION

DO NOT use any alkaline (base) polishes.



Turntable Attachments

The bolts attaching the turntable assembly to the rotation bearing are 5/8-11 NCX 2" long-grade 8. They are special bolts with self-locking threads. Should replacement be necessary, they must be replaced with an equivalent bolt (contact Sutphen Towers, Inc. for detailed requirements).



There are 28 bolts on the turntable. These bolts have a SAE hardened washer and are factory-installed to torque of 200-210 ft. lbs. This torque should be checked every three (3) months. Any indication of loosening or bolt failure should be reported to Sutphen Towers, Inc. for evaluation and disposition.

There are 22 bolts attaching the rotation bearing to the support structure. They are 5/8-11 NCX 4 1/2" long-grade 8 with an SAE hardened washer under the head and a grade "C" lock nut. These assemblies are factory-installed to a torque of 200-210 ft. lbs. and should be checked every three (3) months. The heads of these bolts are accessible through two 3" diameter holes in the turntable plate.

The turntable must be rotated for access to check all bolts. Any indication of loosening or bolt failure should be reported to Sutphen Towers, Inc. for evaluation and disposition.



CAUTION

The person operating the turntable for bolt alignment must make sure all persons and tools are free and clear before rotating turntable.

Attachment of Support Structure to Truck Frame

Huck Fasteners:

There are 18 fasteners on each side of the aerial support structure. These fasteners are 16mm Huck Bobtail Lockbolts. These fasteners are factory installed with specialized equipment, and do not require re-torquing.

They should be inspected every three months. Any indication of loosening or bolt failure should be reported to Sutphen Towers, Inc. for evaluation and disposition.

NOTE: Sutphen recommends that once a week the ladder is raised to full elevation, full extension, and rotated 360 degrees in both directions.

Aerial Tower & Ice Build Up

A well lubed boom, UHMW and other non-metal surfaces will also have low stiction regarding ice. But if the conditions are optimal for ice formation and/or another aerial is being used upwind from our boom, ice will build up unless steps are taken to minimize the buildup. Including moving the boom intermittently. You still need to observe cord reel during extend or retract operations in the unlikely event ice has accumulated on electric cord.

1. Raise/lower & rotate the boom to help break any built-up ice as much as possible; do not retract or extend.
2. Get up on the climbing ladder and/or rotate the boom, lower it off to one side if possible and check the cord reel; you'll want to remove any pieces of ice that could cause damage.
3. Retract the boom slowly while making sure everything is moving freely without any ice and/or other debris getting bound up between the sections, cables, climbing ladders, or cord reel.



4. Refrain from using tools to break the ice off-but if just needing to remove random build up make sure it's a plastic type of tool and use as little force as possible. No metal hammers or pry bars.
5. Using direct flame is also a bad idea: too much plastic, cable loom/sheathing, and UHMW blocks that end up getting burnt and would then need replaced. It would be possible to use portable torpedo Oil/Kerosene heaters, extreme caution is advised, but wind could render this option useless.







CAUTION

Retracting with ice built up can result in a full cord reel replacement, and some lacings & crossmembers. If it must be done, the hydraulics will ultimately win the battle.

Maintenance Manual

AERIAL TOWER LUBRICATION AND MAINTENANCE SCHEDULE

LUBRICATION POINTS	LUBRICANT	INTERVAL	MONTHLY	ANNUALLY
STABILIZERS	Pro-One EP-2 Grease	AS NEEDED OR		X
MAIN LIFT CYLINDER	Pro-One EP-2 Grease	25 OPERATING HOURS OR		X
PIVOT SHAFT BEARING	Pro-One EP-2 Grease	25 OPERATING HOURS OR		X
TURNTABLE BEARING	Pro-One EP-2 Grease	FIRST 3 MO. THEN		X
DRIVE GEAR	Pro-One EP-2 Grease	AS NEEDED OR		X
ROTATION GEAR	140 wt. Gear Oil	AS NEEDED OR		X
EXTENSION-RETRACTION CYLINDER(S)	Pro-One EP-2 Grease (SL75 only)	EVERY 6 MONTHS OR		X
OUTRIGGER PINS	Pro-One EP-2 Grease		X	X
SHEAVES	Pro-One EP-2 Grease	25 OPERATING HOURS OR	X	X
CABLES	Vitalife 400 OR  Chain Mate	25 OPERATING HOURS OR	X	X
SLIDE BLOCKS	Pro-One EP-2 Grease 	25 OPERATING HOURS OR	X	X
WATERWAY AND SEALS	30 wt. Non-Detergent Motor Oil/ATF DexMerc 		X	
WATERWAY NOZZLE	Pro-One EP-2 Grease			X
HYDRAULIC OIL	DexMerc 	ADD AS NEEDED		2 YRS.
HYDRAULIC OIL FILTER(S)	None Required	CHANGE AT 50 OPERATING HOURS or FIRST 3 MONTHS (whichever comes first) THEN		X

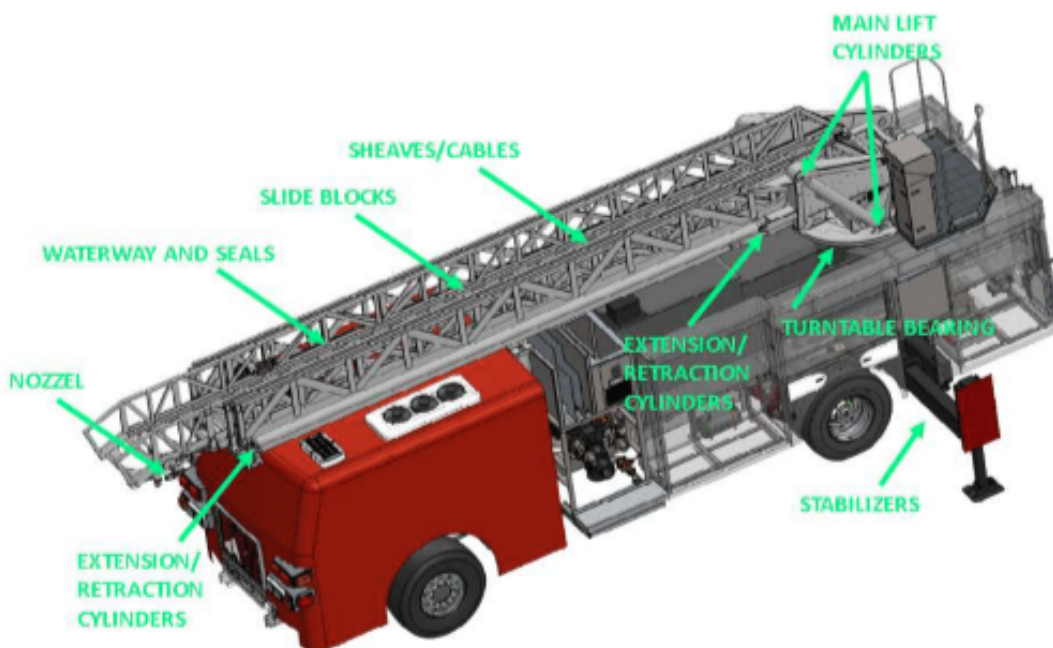
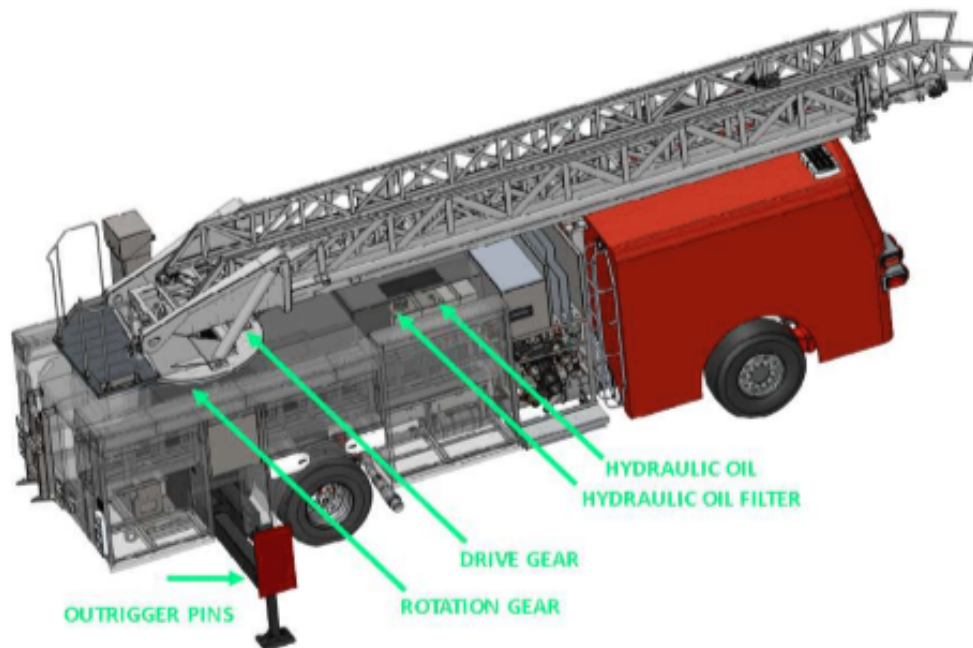

▼ **Maintenance Manual**

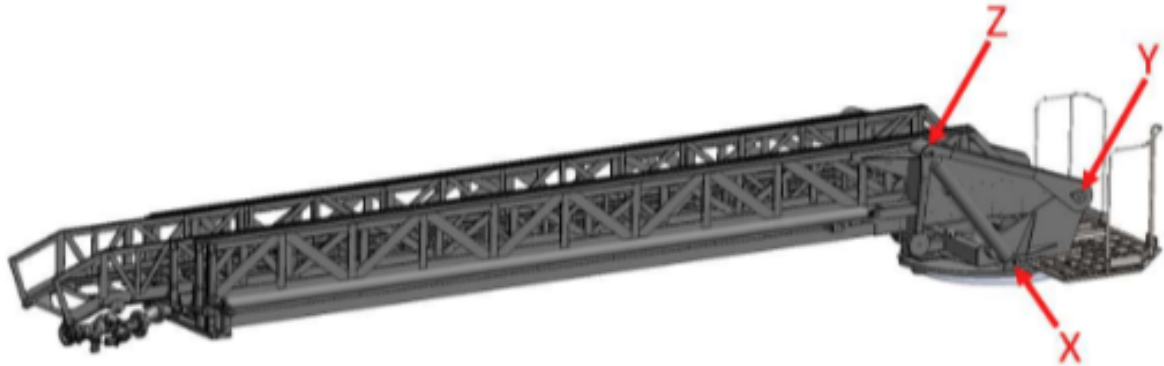

X. Main lift cylinder - Bottom (Pro-One EP-2 Grease) 

Y. Pivot Shaft Bearings (Pro-One EP-2 Grease) 







Z. Main lift cylinder - Top (Pro-One EP-2 Grease) 

NOTE: Before install-coat the bearing pin with red bearing grease lubricant.

NOTE: Secure all bearing pins - 1/4"-20 Grade 8 Allen head bolt/Stover nut.



TORQUE SPECIFICATIONS

ITEM	TORQUE	INTERVAL	MONTHLY	ANNUALLY
#1. TURNTABLE TO ROTATION BEARING	150 - 200 FT. LBS. 	FIRST 3 MO. THEN		X
#2. ROTATION BEARING TO SUPPORT STRUCTURE	150 - 200 FT. LBS. 	FIRST 3 MO. THEN		X
#3. LOWER ASSEMBLY SIDE PLATE TO TRUCK FRAME	VISUAL INSPECTION ONLY FOR HUCK FASTENERS	FIRST 3 MO. THEN		X
#4. ROTATION GEAR MOUNTING (WINSMITH BOLTS)	75 - 100 FT. LBS. 	FIRST 3 MO. THEN		X
#5. WATERWAY MOUNT BOLTS	45 FT. LBS. 	FIRST 3 MO. THEN		X
#6. CYLINDER MOUNT BOLTS	25 - 35 FT. LBS. 	FIRST 3 MO. THEN		X
#7. CABLE ADJUSTMENTS	-----	FIRST 3 MO. THEN	X	
#8. SHEAVE BEAM BOLTS	20 - 25 FT. LBS. 	FIRST 3 MO. THEN		X
#9. SLIDE BLOCK BOLTS	24 In. LBS. 	FIRST 3 MO. THEN		X

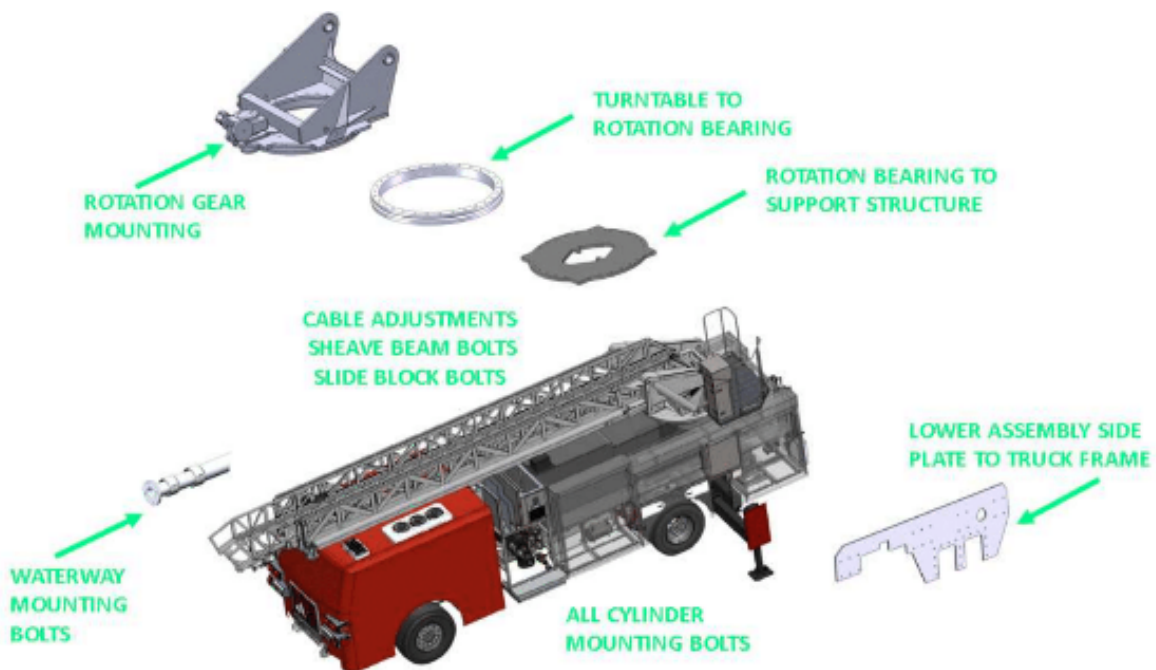

**WALK-AROUND CHECKS
FOR MOBILE FIRE APPARATUS**

Fire Department Name:	Date:	Special Instructions:
Truck Model:	HS #:	
Truck Number:	Station #:	
Start Mileage:	Start Engine Hours:	
End Mileage:	End Engine Hours:	

Legend: Rec Min. = Recommended Minimum Interval for Inspection

OPERATIONS	Daily	Weekly	Monthly	6 Months	Annual
Engine – Tilt Cab – Make sure safety prop is engaged and there are no obstructions on the bumper or in the cab.					
1. Check engine oil and transmission level. Check for leaks (see Manual).	Rec Min.				
2. Check engine coolant level – sight glass. Check for leaks.	Rec Min.				
3. Check for integrity of frame and suspension, as well as motor assembly and mount. Check for loose bolts.			Rec Min.		
4. Check power steering fluid level and look for leaks at fitting or hoses. Transynd	Rec Min.				
5. Check belts for tightness and wear.	Rec Min.				
6. Check steering shafts.			Rec Min.		
7. Check for exhaust leaks. Check heat shields are in place.			Rec Min.		
Outside					
1. Check for fluid leaks under vehicle.	Rec Min.				
2. Check steering shafts and linkages.			Rec Min.		
3. Check wheels and lug nuts for tightness.			Rec Min.		
4. Check tire condition. – Tread Depth. (wear/damage)	Rec Min.				
5. Check tire air pressure.	Rec Min.				
6. Verify all warning label & placards are in place (see Manual).		Rec Min.			
7. Check driveline U-joints and slip joints. Lubricate if necessary. Check for tightness on all universal bolts. Visual check.			Rec Min.		
Cab – lower cab					
1. Check seats and seat belts (damage/warning system) and ensure working properly.	Rec Min.				
2. Start engine, check all gauges, switches, & controls.	Rec Min.				
3. Check windshield wipers & washer fluid level check	Rec Min.				
4. Check rear view mirrors adjustment and operation. R & L	Rec Min.				
5. Check horn, air horn, siren and backup alarm.	Rec Min.				
6. Check all gauges for correct reading after start. Fuel Level Check.	Rec Min.				
7. Check cab glass and mirrors.	Rec Min.				
Body					
1. Check steps and running boards. (damage/loose hardware)	Rec Min.				
2. Check body condition. (doors/latching)	Rec Min.				
3. Check grab handles. (hardware tight secure)	Rec Min.				
Electric					
1. Check battery voltage and charging system voltage, 13 +VDC.	Rec Min.				
2. Check all lights (ICC and warning); headlights.	Rec Min.				

OPERATIONS	Daily	Weekly	Monthly	6 Months	Annual
3. Check operation of battery charger and receptacle.	Rec Min.				
Brakes					
1. Check air system for proper air pressure. (see tech manual)	Rec Min.				
2. Check parking brake operation.	Rec Min.				
3. Check air compressor operations. Cut in _____ Cut out _____	Rec Min.				
4. Check hoses or lines for rubbing.			Rec Min.		
5. Drain wet air tank to make sure air dryer is working properly			Rec Min.		
Pump					
1. Operate pump, check pump panel engine gauges.	Rec Min.				
2. Check pump for pressure operation.	Rec Min.				
3. Check discharge relief or pressure governor operation.	Rec Min.				
4. Check all pump drain valves.		Rec Min.			
5. Check all discharge and intake valve operation.		Rec Min.			
6. Check pump and tank for water leaks.		Rec Min.			
7. Check all valve bleeder/drain operation.		Rec Min.			
8. Check primer pump operation.			Rec Min.		
9. Check system vacuum hold.			Rec Min.		
10. Check water tank level indicator.	Rec Min.				
11. Check primer oil level (if applicable).		Rec Min.			
12. Check transfer valve operation (if equipped).			Rec Min.		
13. Check booster reel operation (if equipped).		Rec Min.			
14. Check all pump pressure gauge operation.	Rec Min.				
15. Check all cooler valves.			Rec Min.		
16. Check for oil leaks in pump area.	Rec Min.				
17. Check oil level of pump transmission.			Rec Min.		
18. Check hour meter operation (If equipped)	Rec Min.				
19. Check operation of valve linkage.	Rec Min.				
20. Check ball valves for leaks.		Rec Min.			
21. Check drain valves.		Rec Min.			
Generator					
1. Operations – Hydraulic, Gas, or Diesel	Rec Min.				
2. Fluid levels	Rec Min.				
3. Breakers, Receptacles, lighting for operations		Rec Min.			
4. Voltage Reading, 240V AC		Rec Min.			
Amp Reading		Rec Min.			
HTZ Reading, 60HTZ		Rec Min.			
Aerial Device					
1. Visually inspect aerial structure, slide blocks, cables, sheaves, lacing bolts/ huck bolts and any moving assembly.		Rec Min.			
a. Sheaves – lubed and look for signs of wear		Rec Min.			
b. Slide blocks – all in place (no visible signs of excess wear or damage)		Rec Min.			
2. Check aerial operation – all controls, bucket & pedestal.		Rec Min.			
3. Elevation cylinder, check for leaks & wiper seal (check RAM for pits and/or damage).		Rec Min.			
4. Extension cylinder, check for leaks & wiper seal (check RAM for pits and/or damage).		Rec Min.			
5. Lines & hoses – check for leaks and cuts.		Rec Min.			
6. Check aerial hour meter operation and record hours.		Rec Min.			

OPERATIONS	Daily	Weekly	Monthly	6 Months	Annual
7. Check breathing air system.		Rec Min.			
8. Cable adjustment not too tight and not too loose check all cables and sections. Review tolerance. (See directions in manual)			Rec Min.		
9. Observe operation of cable track system check for debris and/or damage.		Rec Min.			
Waterway					
1. Check waterway system operation, alignment, and check for damage.		Rec Min.			
Hydraulic System					
1. Check aerial hydraulic fluid level. Dex/Merc		Rec Min.			
2. Check high pressure filter under load to ensure it is still in the green and not in bypass as well as return the filter.		Rec Min.			
3. Turn on auxiliary hydraulic power pump – check operation.		Rec Min.			
Turntable					
1. Operate aerial hydraulics + PTO operation (check for leaks or damaged hoses). Verify Indicator Light is functional.		Rec Min.			
2. Rotation		Rec Min.			
3. Rotation hydraulic swivel, check for leaks		Rec Min.			
4. Lines and hoses (for leaks & cuts)		Rec Min.			
5. Pivot pin bolts tight on boom to turn table pivot bearing plate (Heal Pin).			Rec Min.		
6. Check manual overrides.			Rec Min.		
7. Check cradle alignment light and mounting.		Rec Min.			
8. Check pinion and rotation bearing (Winsmith/rotation drives).			Rec Min.		
Turntable Components or Hydraulic Compartment					
1. Safety signs			Rec Min.		
2. Communication system or intercom		Rec Min.			
3. Interlock systems - operational		Rec Min.			
4. High-speed button operational		Rec Min.			
Platform/Bucket					
1. Leveling cylinders, leaks and wiper seal		Rec Min.			
2. Lines and hoses, cuts & leaks		Rec Min.			
3. Check operation of high speed.		Rec Min.			
4. Check operation of intercom system		Rec Min.			
Platform/Bucket (continued)					
5. Check breathing air system in platform - check for leaks and hose condition		Rec Min.			
6. Inspect monitors/turret for operation		Rec Min.			
7. Verify cab avoidance system is operational		Rec Min.			
8. Verify bucket leveling system is operational		Rec Min.			
9. Verify all accessories are secure in the platform		Rec Min.			
Structural Fasteners - See Manual for Reference					
1. Turntable mounting bolts - visual check for tightness				Rec Min.	
2. Chassis Suspension system bolts – visual check for tightness				Rec Min.	
Stabilizers					
1. Check aerial outrigger operation		Rec Min.			
2. Check aerial jack & rotation interlocks for operation		Rec Min.			
3. Indicator lights working		Rec Min.			
4. Jack pads in proper location & serviceable		Rec Min.			
5. Mounting bolts – visual check for tightness		Rec Min.			
6. Verify safety lock pins operation in aerial jacks and in location		Rec Min.			

OPERATIONS	Daily	Weekly	Monthly	6 Months	Annual
7. Cylinders – check for leaks & wiper seals		Rec Min.			
8. Control valve – smooth operation		Rec Min.			
9. Lines & hoses – check for leaks and cuts		Rec Min.			
10. Diverter valve – check for leaks		Rec Min.			
Lubrication					
Grease Parts and Assemble as Required per the Trucks Maintenance Manual:					
1. Sheaves - Min. Wkly or more if hours of operation dictate		Rec Min.			
2. Cables, wipe down with damp cloth. Lubricate with Vitalife 400 or Chain Mate 		Rec Min.			
3. ProOne Grease on boom section, Review and add where needed per manual		Rec Min.			
4. Rotation gear and bearing				Rec Min.	
5. Rotation gear reduction box				Rec Min.	
6. Extension cylinder pins, grease pivot				Rec Min.	
7. Stabilizer extension cylinder pins				Rec Min.	
8. Aerial waterway pipe sections, wipe with Dex/Merc		Rec Min.			
9. Grease turret guns		Rec Min.			
Indicators					
1. Validate rung alignment operation; pedestal and bucket		Rec Min.			
2. PTO engaged in cab		Rec Min.			
3. Aerial alignment light for cradle bedding		Rec Min.			
4. Elevation/inclometer in bucket		Rec Min.			
5. Inclometer in turntable area for truck level.		Rec Min.			
Comments:					



**FAMILY OWNED
SINCE 1890**

Draining & Winterizing Trucks

It is critical, especially during the cold months, to exercise caution when it comes to leaving trucks outside, transporting trucks, or accepting trucks into our possession. Anyone who gets behind the wheel of a truck is responsible for ensuring the truck is properly drained and stored.

Sutphen Guidelines for Draining and Winterizing Trucks

1. Communicate to all that water and foam tanks must be emptied prior to dropping any truck off to Sutphen for service.
2. Drain all trucks left outside completely, including water tanks, pumps, gauges and valves.
3. Ensure all valves (outboard and inline) are open 50% to drain trapped water.
 - Use caution if valve appears to be frozen in place; do not force a valve open or closed. Trucks may need warmed-up prior to operating frozen valves.
4. Run "RV antifreeze" through the foam pump and systems immediately after foam testing (approx. 3 gal.) from October through April.
5. Any truck being "Road Tested" needs to have all valves and drains open 50% to drain any trapped water. After road testing, the tank fill needs to be opened 100% to allow draining back into the pump. Ensure tank fill is turned back to 50% open after tank has fully drained back into the pump.

Please ensure everyone is fully aware of the expectations and follows the same guidelines. Thank you for your cooperation and dedication to avoiding costly repairs.



Chapter 3 Warranty

	<u>Page</u>
Aerial Platform or Aerial Ladder Structural and Corrosion Warranty	
Thirty (30) Years.....	3-2
Aerial Platform and Aerial Ladder Mechanical Warranty	
Two (2) Years	3-3



AERIAL PLATFORM OR AERIAL LADDER STRUCTURAL & CORROSION WARRANTY THIRTY (30) YEARS

SUTPHEN CORPORATION (Sutphen) warrants the original user/purchaser that a new aerial platform or aerial ladder is, and will remain, free of corrosion perforation and structural defects, provided the aerial platform is used in a normal and reasonable manner. An aerial platform or aerial ladder is defined as the mechanically operated telescopic boom constructed of high-strength structural aluminum mounted on the fire truck. Excluded are all hardware, mechanical or electrical items, bucket, yoke and all normal wear items. Truck must be third party tested yearly. The Sutphen hourly maintenance schedule must be sent in to Sutphen for documentation that this work was performed per hourly schedule. This Structural Warranty shall supplement the Standard Vehicle Warranty.

Sutphen's obligation under this limited warranty is subject to the conditions precedent (1) that the claimed failure shall have first appeared during the warranty period; (2) that the original purchaser shall have notified Sutphen in writing of the claimed failure within thirty (30) days after the claimed failure shall have first appeared, and (3) that, unless Sutphen directs otherwise, the claimed failed item or items shall have been returned to Sutphen, or to Sutphen designee, promptly after the notification, with transportation charges prepaid. Sutphen reserves the right to thoroughly examine the vehicle or parts thereof, prior to conducting or approving any repair or replacement, to determine whether the claimed failure is covered by this warranty. Sutphen's obligation under this warranty is strictly limited to repair or replacement as the company may elect.

This limited warranty coverage shall be valid for a period of thirty (30) years from the delivery date to the original user/purchaser. Further, this warranty shall be void if the vehicle is involved in an accident, shows signs of abuse, or evidence of being operated in any improper manner.

This limited warranty covers only repair or replacement of any part of a Sutphen vehicle in which a defect in materials or workmanship appears within the limited warranty period. Examples of items not covered include, but are not limited to:

- A. ---Major components or trade accessories such as purchased chassis, engines, signaling devices, batteries, generators, tires, or transmissions that have a separate warranty by the original manufacturer, or to equipment used in fire fighting.
- B. ---Unauthorized alteration or modification to the vehicle, including the body, chassis or components, after completion of the vehicle assembly by Sutphen and any problems that occur as a result of such alterations or modifications.
- C. ---Damage caused by collision, fire, theft, freezing, vandalism, riot, explosion, acts of God, war or objects striking the vehicle or any damage covered by owner insurance.
- D. ---Damage caused by misuse or improper operation of the vehicle such as driving over curbs, overloading, racing or off-road use.
- E. ---Damage caused by failure to follow the requirements of the maintenance schedule, failure to maintain proper fluid and lubricant levels and failure to follow operating instructions.
- F. ---Towing charges and storage expenses.
- G. ---Incidental expenses such as loss of vehicle use, inconvenience, loss of time, vehicle rental, lodging or travel costs, vacation pay, etc.
- H. ---Hydraulic pressures are not set to the correct PSI
- I. ---Damage caused from exposure to road de-icing compounds or use in an acidic environment.
- J. ---Hydraulic failures caused by incorrect or contaminated oil.
- K. ---Hydraulic cylinder seal after one (1) year of service.

If proper maintenance has not been performed and documented on Sutphen Aerial Platform or Aerial Ladder Inspection forms and the forms sent to Sutphen at the time of check, all coverage is void.

This warranty terminates upon transfer of possession or ownership of the vehicle from the original purchaser.

THIS WARRANTY IS PROVIDED IN EXCLUSION OF ANY AND ALL OTHER REPRESENTATIONS, EITHER EXPRESSED OR IMPLIED, INCLUDING BUT NOT LIMITED TO THE WARRANTIES OF MERCHANTABILITY, FITNESS, AND SUITABILITY FOR BUYER'S INTENDED USE. NO PERSON IS AUTHORIZED TO MAKE ANY REPRESENTATIONS OR WARRANTIES ON BEHALF OF SUTPHEN CORPORATION OTHER THAN SET FORTH HEREIN. ANY MODIFICATION TO THIS WARRANTY MUST BE IN WRITING AND APPROVED BY THE PRESIDENT OF SUTPHEN CORPORATION. THE PROVISIONS OF THIS LIMITED WARRANTY SHALL CONSTITUTE THE SOLE AND EXCLUSIVE REMEDIES OF A SUTPHEN VEHICLE PURCHASER.

For more information contact:
Sutphen Corporation / Warranty Admin.
PO Box 1845 • Springfield, OH 45501
Phone (937) 969-8851 • Toll Free (866) 287-5549



AERIAL PLATFORM AND AERIAL LADDER MECHANICAL WARRANTY TWO (2) YEARS

SUTPHEN CORPORATION (Sutphen) warrants the original user/purchaser that the mechanical components of a new aerial platform or aerial ladder is, and will remain, free of corrosion perforation, structural defects or failure provided that the components are used in a normal and reasonable manner. Mechanical components are defined as the hardware and mechanical items used on an aerial device. This Mechanical Warranty shall supplement the Standard Vehicle Warranty.

Sutphen's obligation under this limited warranty is subject to the conditions precedent (1) that the claimed failure shall have first appeared during the warranty period; (2) that the original purchaser shall have notified Sutphen in writing of the claimed failure within thirty (30) days after the claimed failure shall have first appeared, and (3) that, unless Sutphen directs otherwise, the claimed failed item or items shall have been returned to Sutphen, or to Sutphen designee, promptly after the notification, with transportation charges prepaid. Sutphen reserves the right to thoroughly examine the vehicle or parts thereof, prior to conducting or approving any repair or replacement, to determine whether the claimed failure is covered by this warranty. Sutphen's obligation under this warranty is strictly limited to repair or replacement as the company may elect.

This limited warranty coverage shall be valid for a period of two (2) years from the delivery date to the original user/purchaser. Further, this warranty shall be void if the vehicle is involved in an accident, shows signs of abuse, or evidence of being operated in an improper manner.

This limited warranty covers only repair or replacement of any part of a Sutphen vehicle in which a defect in materials or workmanship appears within the limited warranty period. Examples of items not covered include, but are not limited to:

- A. ---Major components or trade accessories that have a separate warranty by the original manufacturer, or equipment used in fire fighting.
- B. ---Unauthorized alteration or modification to the vehicle, including the aerial, body, chassis or components, after completion of the vehicle assembly by Sutphen and any problems that occur as a result of such alterations or modifications.
- C. ---Damage caused by collision, fire, theft, freezing, vandalism, riot, explosion, acts of God, war or objects striking the vehicle or any damage covered by owner insurance.
- D. ---Damage caused by misuse or improper operation of the vehicle such as driving over curbs, overloading, racing or off-road use.
- E. ---Damage caused by failure to follow the requirements of the maintenance schedule, failure to maintain proper fluid and lubricant levels and failure to follow operating instructions.
- F. ---Normal maintenance items such as lubrication, cables, shives, pivot bearings, pivot shafts, etc.
- G. ---Towing charges and storage expenses.
- H. ---Incidental expenses such as loss of vehicle use, inconvenience, loss of time, vehicle rental, lodging or travel costs, vacation pay, etc.
- I. ---Damage to discharge and compound gauges from freezing.
- J. ---Leaking seals on discharge and suction valves.
- K. ---Damage caused from exposure to road de-icing compounds or use in an acidic environment.
- L. ---Hydraulic failures caused by incorrect or contaminated oil.
- M. ---Hydraulic pressure caused by incorrect PSI settings.
- N. ---Hydraulic cylinder seal after one (1) year service.
- O. ---Electric reels, air reels, electric controls and components.

If proper maintenance has not been performed and documented on Sutphen Aerial Inspection forms and sent to Sutphen at time of check, all coverage is void.

This warranty terminates upon transfer of possession or ownership of the vehicle from the original purchaser.

THIS WARRANTY IS PROVIDED IN EXCLUSION OF ANY AND ALL OTHER REPRESENTATIONS, EITHER EXPRESSED OR IMPLIED, INCLUDING BUT NOT LIMITED TO THE WARRANTIES OF MERCHANTABILITY, FITNESS, AND SUITABILITY FOR BUYER'S INTENDED USE. NO PERSON IS AUTHORIZED TO MAKE ANY REPRESENTATIONS OR WARRANTIES ON BEHALF OF SUTPHEN CORPORATION OTHER THAN SET FORTH HEREIN. ANY MODIFICATION TO THIS WARRANTY MUST BE IN WRITING AND APPROVED BY THE PRESIDENT OF SUTPHEN CORPORATION. THE PROVISIONS OF THIS LIMITED WARRANTY SHALL CONSTITUTE THE SOLE AND EXCLUSIVE REMEDIES OF A SUTPHEN VEHICLE PURCHASER.

For more information contact:
Sutphen Corporation / Warranty Admin.
PO Box 1845 • Springfield, OH 45501
Phone (937) 969-8851 • Toll Free (866) 287-5549