



---

# **SUTPHEN CORPORATION AERIAL 110 AND 112 MODELS OPERATOR AND MAINTENANCE MANUAL**



# **SUTPHEN**

## **IMPORTANT**

**READ AND UNDERSTAND THIS MANUAL BEFORE OPERATING**

**FAILURE TO USE, UNDERSTAND, AND FOLLOW PROPER USAGE INSTRUCTIONS AS MADE AVAILABLE BY SUTPHEN CORPORATION/OPERATOR'S MANUAL, VARIOUS VENDOR SUPPLIED LITERATURE, GUIDELINES OF N.F.P.A., I.S.F.S.I., O.S.H.A., ETC., COULD CAUSE SERIOUS INJURY AND/OR DEATH.**

**SUTPHEN  
Since 1890**

Rev. 17 - May 2024





---

## Chapter 1 Operator Manual

	<i><u>Page</u></i>
1.1 Introduction.....	1-3
1.2 Aerial Platform Operation.....	1-4
<i>Operation Safety Points</i> .....	1-4
1.3 Safety Tags.....	1-8
<i>Warning/Danger/Caution Labels List</i> .....	1-26
<i>Safety Tags Location</i> .....	1-28
<i>Rear/Bucket Warning Tags</i> .....	1-29
<i>Rear/Bucket Warning Tags List</i> .....	1-32
1.4 Cab Setup Procedures .....	1-33
<i>Locating the Vehicle</i> .....	1-33
<i>Activating the Hydraulic System</i> .....	1-33
1.5 Cab Setup for Fire Pump Operation.....	1-34
1.6 Aerial Setup Procedures.....	1-36
1.7 Stabilizing System.....	1-36
1.8 Safety Pins.....	1-41
1.9 Transfer Fluid for Aerial Operation .....	1-43
1.10 Stabilizer Interlock System .....	1-45
<i>Stabilizer Interlock Override Procedure</i> .....	1-45
1.11 Rotation Interlock System.....	1-46
1.12 Smart Boom Warning System.....	1-47
1.13 Aerial Operational Controls .....	1-49
<i>Raise/Lower</i> .....	1-50



	<i>Extend/Retract</i> .....	1-51
	<i>Rotation</i> .....	1-51
	<i>Fairfield Drive Rotation Brake</i> .....	1-52
	General Information .....	1-52
	Location of The Rotation Brake .....	1-53
	Releasing the Brake Valve .....	1-53
	<i>High-Speed Control</i> .....	1-55
	<i>Low Range Switch</i> .....	1-56
	<i>Auxiliary Hydraulic Power Switch</i> .....	1-56
1.14	Water Delivery System .....	1-57
	<i>Telescopic Waterway</i> .....	1-57
	<i>Platform Water System</i> .....	1-58
1.15	Draining the Fire Pump .....	1-58
1.16	Cold Weather Operations .....	1-59
	<i>Draining the Waterway</i> .....	1-59
1.17	Platform Mounting and Leveling System .....	1-60
	<i>Leveling System Override</i> .....	1-60
1.18	Optional Breathing Air System.....	1-61
1.19	Climbing Aerial or Using as an Escapeway.....	1-62
1.20	Rappelling .....	1-62
1.21	Loading Hose .....	1-62
1.22	Aerial Take-Down Procedures .....	1-63
	<i>Stowing the Aerial Device</i> .....	1-63



---

## Chapter 2 Maintenance Manual

	<i><b>Page</b></i>
2.1 Aerial Maintenance .....	2-3
<i>Outrigger Beams</i> .....	2-3
<i>Main Lift Cylinders</i> .....	2-3
<i>Pivot Shaft Bearings</i> .....	2-3
<i>Turntable Bearing</i> .....	2-3
<i>Fairfield Drive</i> .....	2-4
<i>Aerial Extension/Retraction Cylinders</i> .....	2-5
<i>Sheaves and Cables</i> .....	2-5
<i>Cable Adjustment Procedure for     SPI 110, SAI 110, SPH 112 and SP110</i> .....	2-6
Before Extending Aerial .....	2-6
<i>Slide Block</i> .....	2-19
Lubrication .....	2-19
Description .....	2-19
Daily Preventative Maintenance (PM) .....	2-19
Before Beginning .....	2-20
Slide Block Replacement .....	2-20
Standard Operating Procedure .....	2-21
Periodic Preventative Maintenance (PM) .....	2-23
<i>Cable Track</i> .....	2-24
Maintenance .....	2-24
<i>Waterway and Seals</i> .....	2-26

*Hydraulic Oil Tank* ..... 2-27

*Hydraulic Oil Tank Fill Procedure*..... 2-28

*SP 110 Fitted with KFS 4682 Hydraulic Reservoir*..... 2-29

*Fuel Tank* ..... 2-31

2.2 Maintenance of Structure ..... 2-31

*Aluminum Tower Structure* ..... 2-31

*Attachment of Support Structure to Truck Frame* ..... 2-31

*Aerial Tower & Ice Build Up*..... 2-31

2.3 Sutphen-Recommended Torque Schedule  
    for Various Fasteners ..... 2-32

2.4 Daily/Weekly Walk-Around Check for Mobile Fire Apparatus ..... 2-37

2.5 Draining & Winterizing Trucks ..... 2-41

### **Chapter 3**

#### **Warranty**

##### Aerial Platform or Aerial Ladder Structural and Corrosion Warranty

    Thirty (30) Years..... 3-3

##### Aerial Platform and Aerial Ladder Mechanical Warranty

    Two (2) Years ..... 3-4



---

# Chapter 1 Operator Manual

	<u>Page</u>
1.1 Introduction .....	1-3
1.2 Aerial Platform Operation.....	1-4
<i>Operation Safety Points</i> .....	1-4
1.3 Safety Tags.....	1-8
<i>Warning/Danger/Caution Labels List</i> .....	1-26
<i>Safety Tags Location</i> .....	1-28
<i>Rear/Bucket Warning Tags</i> .....	1-29
<i>Rear/Bucket Warning Tags List</i> .....	1-32
1.4 Cab Setup Procedures .....	1-33
<i>Locating the Vehicle</i> .....	1-33
<i>Activating the Hydraulic System</i> .....	1-33
1.5 Cab Setup for Fire Pump Operation.....	1-34
1.6 Aerial Setup Procedures.....	1-36
1.7 Stabilizing System.....	1-36
1.8 Safety Pins.....	1-41
1.9 Transfer Fluid for Aerial Operation.....	1-43
1.10 Stabilizer Interlock System .....	1-45
<i>Stabilizer Interlock Override Procedure</i> .....	1-45
1.11 Rotation Interlock System.....	1-46
1.12 Smart Boom Warning System.....	1-47
1.13 Aerial Operational Controls.....	1-49
<i>Raise/Lower</i> .....	1-50

▽ **Operator Manual**

	<i>Extend/Retract</i> .....	1-51
	<i>Rotation</i> .....	1-51
	<i>Fairfield Drive Rotation Brake</i> .....	1-52
	General Information .....	1-52
	Location of The Rotation Brake .....	1-53
	Releasing the Brake Valve .....	1-53
	<i>High-Speed Control</i> .....	1-55
	<i>Low Range Switch</i> .....	1-56
	<i>Auxiliary Hydraulic Power Switch</i> .....	1-56
1.14	Water Delivery System .....	1-57
	<i>Telescopic Waterway</i> .....	1-57
	<i>Platform Water System</i> .....	1-58
1.15	Draining the Fire Pump .....	1-58
1.16	Cold Weather Operations.....	1-59
	<i>Draining the Waterway</i> .....	1-59
1.17	Platform Mounting and Leveling System .....	1-60
	<i>Leveling System Override</i> .....	1-60
1.18	Optional Breathing Air System.....	1-61
1.19	Climbing Aerial or Using as an Escapeway.....	1-62
1.20	Rappelling .....	1-62
1.21	Loading Hose .....	1-62
1.22	Aerial Take-Down Procedures.....	1-63
	<i>Stowing the Aerial Device</i> .....	1-63





## 1.1 Introduction

This manual has been prepared with the assistance of service and engineering specialists to acquaint you with the operation and maintenance of your new apparatus. You are urged to read this manual carefully. Following the instructions and recommendations in this manual will help ensure the safe and enjoyable operation of your apparatus.

After you have read this manual, it should be stored in the apparatus or another location which enables quick and easy reference for all firefighters.

Throughout this manual, the words WARNING, DANGER, and CAUTION appear. These serve as reminders to follow all instructions carefully. Failure to follow instructions can cause personal injury or damage to your apparatus.

This manual has been written to help in the set up and use of the tower during emergencies.

There may be circumstances that arise throughout the life of this apparatus which do not appear in this manual. At all times, common sense and safety should be your first consideration.

Sutphen knows your apparatus best and has the parts and factory-trained technicians available to keep your apparatus in an ever-ready state. Sutphen Corporation works towards giving you complete satisfaction. Please do not hesitate to contact the Sutphen Service and Technical Division at 866-287-5549.

## **1.2 Aerial Platform Operation**

### **Operation Safety Points**

When the truck is delivered, a factory-trained representative will demonstrate the proper use of the apparatus. The department must continue this to achieve a proficient level of training.

The aerial tower is only as good or as safe as the operator is competent. Continued training and familiarization is essential.

An operator **MUST** be at the lower control station anytime the aerial is being operated.

Personnel should not climb the aerial tower until the lower controls operator indicates that it is safe to do so. The upper power switches must be turned off in the platform and at the turntable pedestal before climbing the ladder.

Rating of the aerial: Model SP 110, SPI 110, SPH 110/112, SAI 110 - 1,000 lbs.

Rating in the bucket: Model SP 110, SPI 110, SPH 110/112, SAI 110 - 500 lbs.  
while flowing water or with charged waterway

Do not operate turntable controls while personnel are climbing the tower.

Personnel should use an approved life belt when operating on the aerial tower.

At night, the entire aerial tower should be well lighted.

Do not forcefully extend the end of the tower against a structure.

Never use the aerial as a battering ram.

Never use the aerial for pulling down walls or structural members.

Never willingly or intentionally abuse an aerial by careless handling, overloading, or use for which it was not designed.



Operate the aerial with deliberate motions and smooth application of power.

Training and practice with the apparatus on a regular basis is a must for safe operation.

Auxiliary ground pads should always be used under the outrigger feet when operating the aerial tower.

Do not use auxiliary ground pads under the rear jacks unless they are metal, as these jacks are used as a grounding point.

Safety lock pins on stabilizers shall always be in place.

Never move the vehicle with stabilizers in contact with ground.

Most problems encountered with operation of the tower are caused by inadequate maintenance. To keep the tower fully operational, routine lubrication policies should be followed.

The aerial should be inspected and tested annually in accordance with NFPA 1914, Testing Fire Department Aerial Apparatus.

Frequently inspect the chassis and running gear and maintain in good mechanical condition following recommended schedules in this manual. The aerial tower is of no use unless it can be transported to where it is needed. Careful, safe driving rules should be observed for the same reason.

Carefully and frequently check and inspect the entire aerial for loose bolts or rivets, unlubricated bearing surfaces, bent, warped, or twisted parts, hydraulic leaks, defective electric control equipment, etc. Follow the recommended maintenance schedules in this manual.

All members should frequently practice the different phases of aerial operations.

Never set up the aerial on marshy ground, freshly filled ground, or other soft surface.

 **Operator Manual**

Never apply opposing alternating control when operating the aerial, either in a side-to-side motion, a front-to-rear motion, or an up-and-down motion. This may set up an accelerated oscillation, which could put undue strain on the structure and cause immediate or eventual failure of the aerial tower and injury to the occupants and bystanders.

Do not overload the aerial. Learn and observe the load limit indicated at the operator's positions.

When raising an aerial platform to rescue people at roofs or windows, avoid raising the platform in line with the people. Either raise off to one side and rotate to the people or raise perpendicular to them and rotate toward them. This is because panic-stricken persons seeing the platform within reach below them could try jumping into it.

Although the aerial is designed for one-person setup, it is a good safety practice to designate a person to observe the right-side stabilizer when the stabilizers are being set up. This person can place the stabilizer pad and observe that it is placed evenly and correctly and that the stabilizer is set properly.

Many accidents with aerial devices nationwide occur during nonemergency operation. For this reason, the aerial should not be operated by one person alone. Operators checking out or operating the tower alone in front of the station can forget something or be overconfident and get into trouble. “Two heads are better than one”.

Never allow an untrained person or a person who is not thoroughly familiar with this aerial to operate it unless constantly supervised.



---

That person must:

1. Be capable of spotting the vehicle properly.
2. Be able to stabilize the vehicle properly.
3. Know the location of every control.
4. Know what each control does and how it works.
5. Be able to operate all controls smoothly and safely.
6. Know the location of safety devices, how they work, and how to operate them.
7. Be familiar with the loads that the aerial can safely accommodate under various operating conditions.
8. Be aware of how to operate the aerial under unusual circumstances.

When you consider the cost of an aerial platform, the lives that could be at stake, and the damage that could occur to the equipment, the importance of practice and training becomes very clear.



## **WARNING**

*Before operating this apparatus you must:*

- 1. Be thoroughly familiar with this instruction manual.*
- 2. Be thoroughly trained in the operation of this apparatus.*
- 3. Operate this apparatus in strict accordance with the manufacturer's recommendations.*
- 4. Operate this apparatus in accordance with departmental rules and regulations.*
- 5. Always set up the apparatus on concrete, blacktop, or gravel. Surface must be firm and solid.*

*Failure to do so could result in injury or death to persons operating or working on or around this apparatus.*

*Failure to do so could also result in damage to this apparatus.*

### **1.3 Safety Tags**

On the following pages are the various safety tags found on the apparatus. All of the tags found here may not be used on your particular vehicle, as some are related to optional equipment. Included in this manual is a drawing showing the locations of these various tags on the apparatus. Should any of these tags become damaged or lost throughout the life of your vehicle, please contact Sutphen Corporation at 1-866-287-5549 for replacements.



## Safety Tags

TAG 16



3.13 x 1.88



TAG 15



TAG 17



TAG 10



Sutphen-5

Operator Manual

TAG 22



7.25 x 3.50

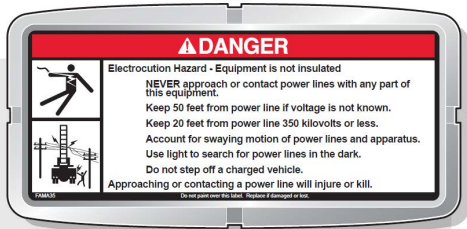

6.63 x 2.75

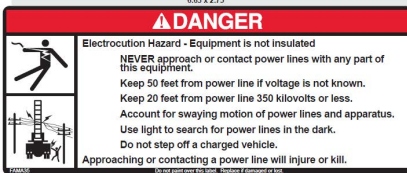

FAMA 35

3.50 x 3.50



TAG 21







TAG 38-1



TAG 56



TAG 57



TAG 36



TAG 38



Sutphen-7

TAG 55

## SAFETY INSTRUCTIONS

### Jump Starting Precautions:

1. Jump starting with voltages greater than 16 volts DC or reversing the polarity will damage the engine computer.
2. Before attempting to jump-start the engine, make sure jumper cables are connected properly (positive to positive, negative to negative) and in the proper sequence (connect positive to positive first). Failure to do so can result in alternator and/or equipment damage.
3. Reversing battery polarity can also result in personal injury caused by a sudden discharge of electrolyte from the battery vents or by the sudden rupture of the battery case caused by an explosion of internal hydrogen gas.

### Battery Charging Precautions

1. When using battery charger to charge batteries, set on 12 VOLT LOW CHARGE. Do not exceed a maximum of 16 volts DC.
2. Electrical damage or explosion can occur when charging batteries or boosting batteries.

### Welding Precautions:

1. Serious damage to the ECM(s) and DDEC components may result from welding if all ECM connectors are not disconnected.
2. Serious damage to the multiplexed platform controls may occur if the power supply to them is not disconnected.

Sutphen

**HIGH SPEED**

TAG 356



TAG 66



TAG 281

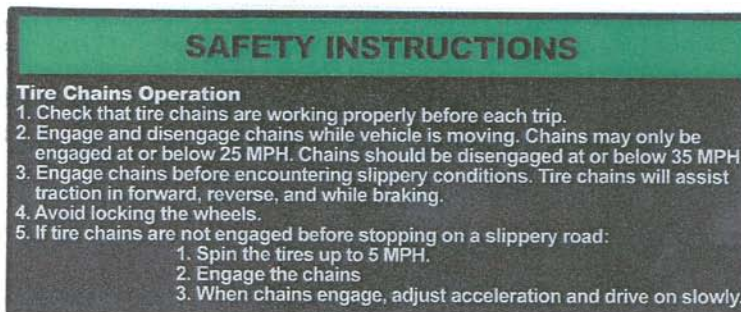

TAG 59



TAG 58



Sutphen-9

**Operator Manual**

**SAFETY INSTRUCTIONS**

**Before raising cab:**

1. Read operator manual.
2. Provide sufficient cab clearance.
3. Secure or remove any loose items.
4. Make sure nothing is on the front bumper.
5. Make sure cab doors are shut and latched.
6. Make sure cab tilts fully and the safety bar engages.

**Before lowering cab:**

1. Make sure all service items are removed from engine area.
2. Raise cab to maximum height to release safety latch.
3. Make sure all personnel are clear of cab area.
4. Pull safety latch handle and hold out to lower cab.

**TAG 323**

**TAG 328**

**⚠ DANGER**



**Fall Hazard**

Do not open valves completely. Use only in an emergency.

**TAG 322**

**⚠ WARNING**



Crushing injuries may occur.

Stand clear when lowering cab.

**TAG 327**

**SAFETY INSTRUCTIONS**

**Leveling System Override:**

1. For emergency use only
2. Open only if automatic leveling system fails.
3. Open both valves one turn.
4. Read operator's manual before operating this equipment.

**TAG 310**

**Computer Code Switch**

**TAG 324**

**Cab Tilt**

Up



Down

**TAG 325**

**Cab Tilt Safety Latch**

**Pull to Release**

Sutphen-16



TAG 326



Sutphen-11

▽ **Operator Manual**

TAG 385



TAG 365

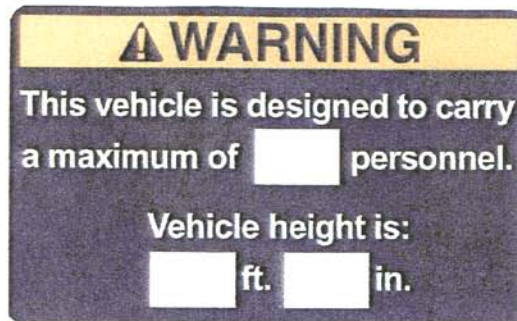

TAG 355



Sutphen-12



**▲ WARNING** TAG 382

Serious injury or death may occur if inlets are supplied by a pressurized source when valve is closed.

TAG 381

ABS Code Switch

TAG 370

All equipment in the platform must be mounted in a holder. The total weight of equipment should not exceed 80 lbs.

7.25 x 3.50

**▲ WARNING**

Only trained personnel should operate this equipment. Personnel connecting supply or discharge hoses must be trained to recognize and respond to water hydraulics hazards and component limitations.

Do not operate or service until you have read, understood, and been trained and qualified on the procedures found in the latest editions of NFPA standards including 1511, 1451, 1500; IFSTA Handbooks; and the operation and service manuals supplied with this equipment. Replacement manuals are available from the manufacturer of this apparatus. Operating or servicing without knowledge or training may lead to injury or death for you or others.

6.63 x 2.75

**▲ WARNING**

Only trained personnel should operate this equipment. Personnel connecting supply or discharge hoses must be trained to recognize and respond to water hydraulics hazards and component limitations.

Do not operate or service until you have read, understood, and been trained and qualified on the procedures found in the latest editions of NFPA standards including 1511, 1451, 1500; IFSTA Handbooks; and the operation and service manuals supplied with this equipment. Replacement manuals are available from the manufacturer of this apparatus. Operating or servicing without knowledge or training may lead to injury or death for you or others.

FAMA 25

TAG 375

**▲ CAUTION**

Properly set rear jacks before raising the boom to load hose, fill water tank, etc.

Failure to do so may result in body or chassis damage.

TAG 368

**To Engage PTO:**

1. Bring engine to idle.
2. Move PTO switch to ON position.
3. Confirm that PTO dash light is on.
4. Resume operations.

Sutphen-13

**Operator Manual**

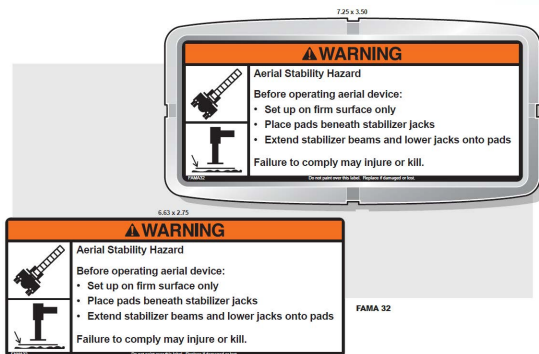
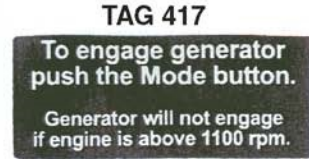

Sutphen-14





TAG 405

⚠ DANGER

Electrocution Hazard

Death or serious injury may result from contact with this vehicle if it should be electrically charged.

Maintain 17 foot minimum clearance from all power sources during aerial operations.

Pump operator must use pull-out safety platform during aerial operations.

Always designate a spotter at pedestal to help avoid power lines during aerial operations.

Avoid simultaneous contact with truck and ground during aerial operations.

Stuphen-15

⚠ DANGER

**Electrocution Hazard - Equipment is not insulated**

**NEVER** approach or contact power lines with any part of this equipment.

Keep 50 feet from power line if voltage is not known.

Keep 20 feet from power line 350 kilovolts or less.

Account for swaying motion of power lines and apparatus.

Use light to search for power lines in the dark.

Do not step off a charged vehicle.

Approaching or contacting a power line will injure or kill.

FAMA36 Do not paint over this label. Replace if damaged or lost.

⚠ WARNING

**Fall Restraint Required**

All personnel on aerial ladder or platform must wear safety harness with restraint belt properly attached to the device.

Fall will injure or kill.

FAMA34

Do not paint over this label. Replace if damaged or lost.

⚠ WARNING

**Fall Restraint Required**

All personnel on aerial ladder or platform must wear safety harness with restraint belt properly attached to the device.

Fall will injure or kill.

FAMA34

Do not paint over this label. Replace if damaged or lost.

FAMA 34

Operator Manual



TAG 440

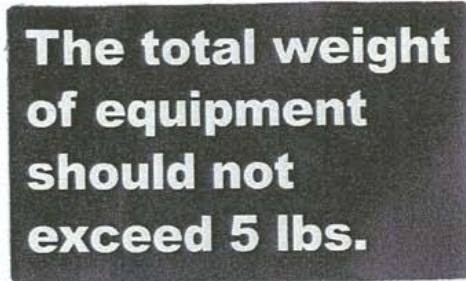

TAG 438

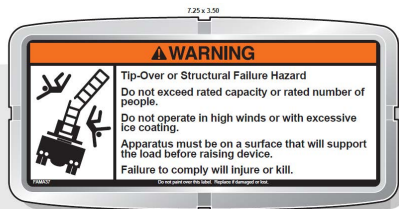

TAG 436

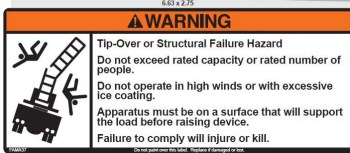

TAG 426

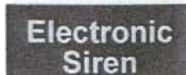

TAG 425



TAG 424

TAG 435



Sutphen-16



TAG 406

UP	RET	RET	RET	RET	UP	UP
Front Axle Lock	Left Front Stabilizer	Left Rear Stabilizer	Right Front Stabilizer	Right Rear Stabilizer	Right Stabilizer	Left Stabilizer
DOWN	EXT	EXT	EXT	EXT	DOWN	DOWN

TAG 414

# INSTALL SAFETY PINS

**⚠ WARNING**

**Inspection Required**  
Follow the instructions in the operator's manual and NFPA 1911 for daily, frequent, and annual inspection and maintenance.

**Operation of a poorly inspected aerial device may injure or kill.**

FAMA39 Do not paint over this label. Replace if damaged or lost.

7.25 x 3.50

**⚠ WARNING**

**Operator Attention Required**  
Trained operator must remain at primary controls any time there are personnel on the device.  
Do not operate this device using platform or tip controls without a trained operator at the primary controls at all times.  
Be alert for changing conditions and be prepared to remove device personnel from danger.  
Failure to comply may injure or kill.

FAMA47 Do not paint over this label. Replace if damaged or lost.

6.63 x 2.75

**⚠ WARNING**

**Operator Attention Required**  
Trained operator must remain at primary controls any time there are personnel on the device.  
Do not operate this device using platform or tip controls without a trained operator at the primary controls at all times.  
Be alert for changing conditions and be prepared to remove device personnel from danger.  
Failure to comply may injure or kill.

FAMA47 Do not paint over this label. Replace if damaged or lost.

FAMA 47

Operator Manual

TAG 431

	<b>CHASSIS DATA</b>		Sutphen Corporation 7000 Columbus-Marysville Road Amlin, OH 43022 (800) 848-5860	
	<b>CHASSIS FILTERS</b>			
CHASSIS ENGINE OIL FILTER PART NO.	<input type="text"/>			
TRANSMISSION OIL FILTER PART NO.	<input type="text"/>			
CHASSIS AIR CLEANER FILTER PART NO.	<input type="text"/>			
CHASSIS FUEL FILTER PRIMARY PART NO.	<input type="text"/>			
CHASSIS FUEL FILTER SECONDARY PART NO.	<input type="text"/>			
CHASSIS ENGINE WATER FILTER PART NO.	<input type="text"/>			
AIR DRYER ASSEMBLY FILTER PART NO.	<input type="text"/>			
AERIAL HYDRAULIC FILTER CARTRIDGE PART NO.	<input type="text"/>			
<b>CHASSIS SPECIFICATIONS</b>				
MODEL	<input type="text"/>	TRUCK NO.	<input type="text"/>	
FRONT TIRES	<input type="text"/>	REAR TIRES	<input type="text"/>	
ENGINE	<input type="text"/>			
SERIAL NO.	<input type="text"/>	NO. CYLINDERS	<input type="text"/>	
BORE	<input type="text"/>	STROKE	<input type="text"/>	
H.P. SAFE	<input type="text"/>	DISPLACEMENT	<input type="text"/>	
PAINT COLOR	<input type="text"/>			

TAG 430

	Sutphen Corporation 7000 Columbus-Marysville Road Amlin, OH 43022 (800) 848-5860		<b>PUMP DATA</b>		
			PUMP MAKE	<input type="text" value="HALE"/>	
		<b>GPM</b>	<b>PRESSURE</b>	<b>ENGINE RPM</b>	
		<input type="text" value="XXXXXX"/>	150 PSI	<input type="text" value="XXXXXX"/>	
		<input type="text" value="XXXXXX"/>	200 PSI	<input type="text" value="XXXXXX"/>	
		<input type="text" value="XXXXXX"/>	250 PSI	<input type="text" value="XXXXXX"/>	
CAPACITY	<input type="text" value="1500"/>	GPM			
MODEL NO.	<input type="text" value="QMAX 150-23S"/>		GOVERNOR SPEED	<input type="text" value="2100"/>	RPM
SERIAL NO.	<input type="text" value="QMAX 150-23S"/>		GEAR RATIO	<input type="text" value="2.28"/>	TO 1
PRODUCTION NO.	<input type="text" value="QMAX 150-23S"/>				

Sutphen-18



TAG 434



!
WARNING

Keep legs and feet inside kick guard during aerial operations. Failure to do so may result in serious injury or death.

POWER SOURCE SPECIFICATIONS	
OPERATIONAL CATEGORY	CONTINUOUS DUTY RATING
RATED VOLTAGE(S) AND TYPE (AC OR DC)	XXXXXX
PHASE	XXXXXX
RATED FREQUENCY	XXXXXX
RATED AMPERAGE	XXXXXX
CONTINUOUS RATED WATTS	XXXXXX
POWER SOURCE ENGINE SPEED	XXXXXX

TAG 433

TAG 432



## FLUID DATA

Sutphen Corporation  
7000 Columbus-Marysville Road  
Amlin, OH 43022  
(800) 848-5860

		QTY.	TYPE			QTY.	TYPE
CHASSIS ENGINE OIL				CAB TILT MECH. FLUID			
CHASSIS ENGINE COOLANT				TRANSFER CASE FLUID / AUTO LUBE			
CHASSIS TRANSMISSION FLUID				EQUIPMENT RACK FLUID			
PUMP TRANSMISSION FLUID				GENERATOR SYSTEM LUBRICANT			
PUMP PRIMER FLUID				AERIAL-TOWER HYDRAULIC FLUID			
DRIVE AXLE LUBRICATION FLUID				LEVELING SYSTEM FLUID			
AIR-CONDITIONING REFRIGERANT FLUID				FUEL TANK DIESEL NO. 2			
AIR-COND. LUBRICAT. OIL SYS. LUBRICANT				FRONT TIRE COLD PSI			
POWER STEERING FLUID				REAR TIRE COLD PSI			
MONTH-YEAR BUILT				DATE SHIPPED			
VEHICLE IDENTIFICATION NO.							HS-

Sutphen-19

TAG 442

<b>▲ WARNING</b>	<b>▲ WARNING</b>	<b>▲ WARNING</b>
Maximum lifting eye capacity of 800 lbs.	Static load only. No rappelling from platform.	Any weight suspended from lifting eye must be subtracted from available platform payload.

TAG 446

<b>SAFETY INSTRUCTIONS</b>
1. Lifting eye capacity - 800 lbs. 2. Any weight suspended from eye must be subtracted from platform capacity.

Sutphen-20



TAG 448

**WHEN DIFFERENTIAL LOCK  
IS ENGAGED, THE  
MAXIMUM SPEED IS  
25 MPH**

TAG 449

**⚠ CAUTION**  
When filling water tank, do not  
exceed 100 psi. Failure to do so  
could cause the tank to rupture.

TAG 454

**⚠ WARNING**  
Do Not Exceed  
Wattage Rating  
of Generator.  
Generator may be  
Permanently  
Damaged  
and Void Warranty.

TAG 452

**GEN.  
PTO**

TAG 455

**Ladder Belt  
Tie-Off Point**  
**⚠ WARNING**  
Not For  
Rescue or  
Rappelling  
250lb. Max.

Sutphen-21

**Warning/Danger/Caution Labels List**

TAG 10	ALIGNMENT LIGHT
TAG 15	DO NOT MODIFY
TAG 16	DO NOT GET OIL IN EYES
TAG 17	STAND ON STEP - ELECTROCUTION
TAG 18	PINCH POINT
TAG 19	CRUSHING INJURY
TAG 20	ELECTROCUTION HAZARD
TAG 21	LIFTING EYE
TAG 22	DO NOT CLIMB BOOM
TAG 23	AERIAL DATA PLACARD
TAG 36	FIRE MAY OCCUR
TAG 37	SEAT BELTS FASTENED
TAG 38	BREATHING OF FUMES
TAG 38-1 HORZ.	BREATHING OF FUMES
TAG 55	JUMP STARTING PRECAUTIONS
TAG 56	EXPLOSION MAY OCCUR - BATTERIES
TAG 57	OCCUPANTS MUST BE SEATED
TAG 58	DO NOT USE AUXILIARY BRAKING
TAG 59	STAY CLEAR OF FAN
TAG 66	STAND CLEAR OF OUTRIGGER
TAG 281	TIRE CHAIN OPERATION
TAG 310	COMPUTER CODE SWITCH
TAG 322	STAND CLEAR - LOWERING CAB
TAG 323	BEFORE RAISING CAB
TAG 324	CAB TILT UP & DOWN
TAG 325	CAB TILT SAFETY LATCH
TAG 326	DO NOT RAPPEL FROM AERIAL
TAG 327	LEVELING SYSTEM OVERRIDE
TAG 328	FALL HAZARD
TAG 353	SUTPHEN - TEAMSTER LOGO
TAG 356	HIGH SPEED
TAG 365	CARRY MAX. PERSONNEL
TAG 368	TO ENGAGE PTO
TAG 370	EQUIPMENT MOUNTED
TAG 375	SET REAR JACKS
TAG 381	ABS CODE SWITCH
TAG 382	PRESSURIZED INLETS
TAG 385	POSITIVE/NEGATIVE
TAG 395	FLOW OR RECIRCULATE
TAG 396	DO NOT WALK ON SURFACE





### Warning/Danger/Caution Labels List - Continued

TAG 405	ELECTROCUTION HAZARD
TAG 406	MANUAL LEVERS OVERRIDE
TAG 407	PEDESTAL AREA
TAG 408	LOCK - DOWN
TAG 409	EXITING BUCKET
TAG 410	EXITING CAB
TAG 414	INSTALL SAFETY PINS
TAG 416	SAFETY CHAIN FASTENED
TAG 417	ENGAGE GENERATOR
TAG 424	AIR HORN
TAG 425	ELECTRIC SIREN
TAG 426	MECHANICAL SIREN
TAG 427	DO NOT WALK ON SURFACE
TAG 430	PUMP DATA PLACARD
TAG 431	CHASSIS DATA PLACARD
TAG 432	FLUID DATA PLACARD
TAG 433	POWER SOURCE SPECS.
TAG 434	KEEP FEET INSIDE KICK GUARD
TAG 435	KUSSMAL AUTO-PUMP DRAIN
TAG 436	FRONT SUCTION - RAISING CAB
TAG 438	WATERWAY VALVE OVERRIDE
TAG 440	EQUIPMENT LIMITS - 5 LB. (BUCKET)
TAG 442	BUCKET STATIC LOAD
TAG 443	PUMP DATA PLACARD (METRIC)
TAG 444	TIRE PRESSURE FR. 120 R. 95
TAG 445	TIRE PRESSURE FR. 120 R. 110
TAG 446	LIFTING EYE CAPACITY 800 LB.
TAG 448	DIFFERENTIAL LOCK ENGAGEMENT
TAG 449	WATER TANK REFILL
TAG 451	HYDR. COMPT. JACK CONTROL 95/100
TAG 452	GENERATOR PTO
TAG 453	TIRE PRESSURE (AERIAL)
TAG 454	GENERATOR
TAG 455	LADDER BELT TIE-OFF POINT

### Safety Tags Location

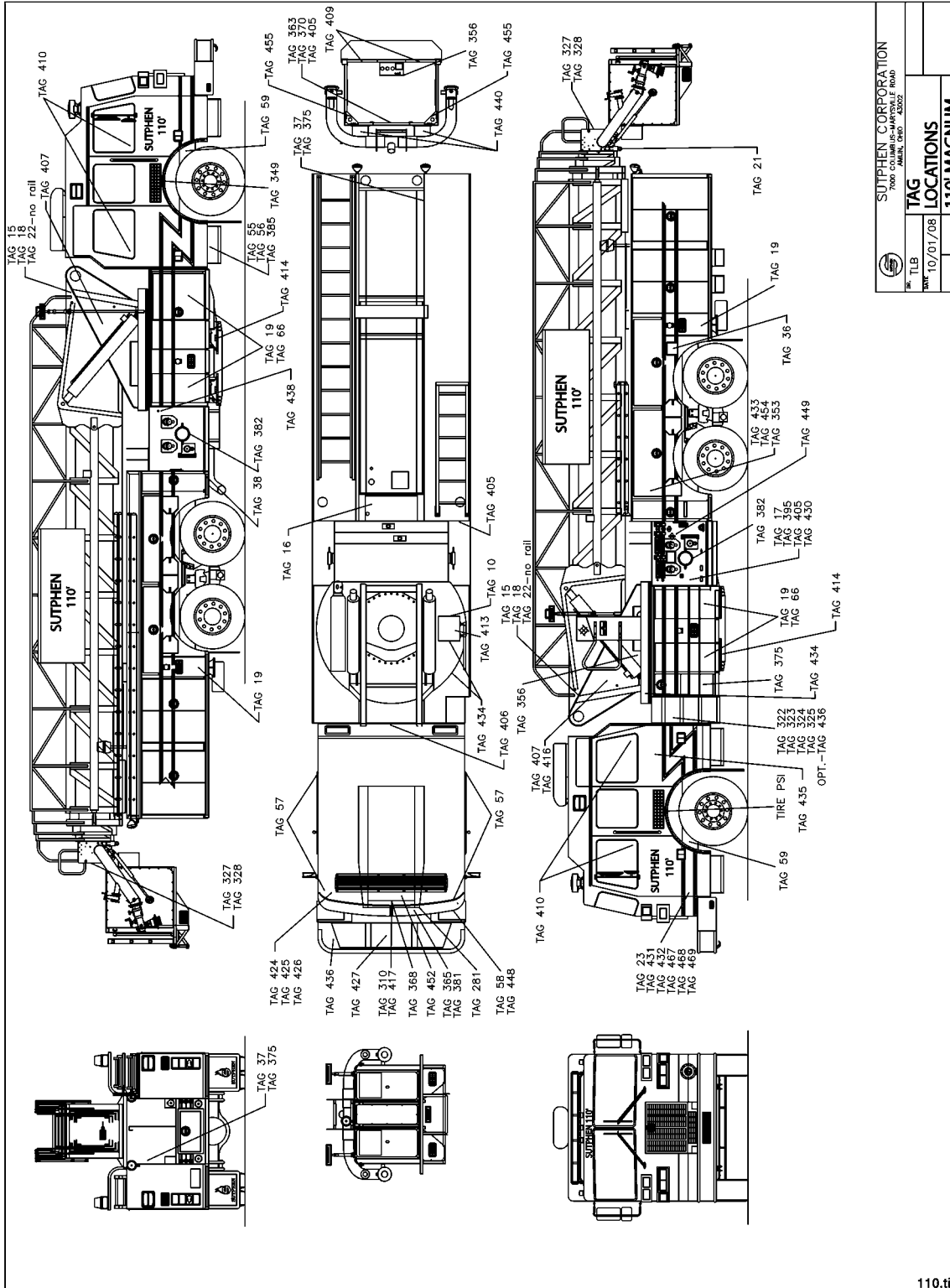

SUTPHEN CORPORATION 7000 COLUMBIAN-MAKWALE ROAD JAMES CITY, MISSISSIPPI	
TAG LOCATIONS DATE: 10/01/08 110' MAGNUM	TAG 15 TAG 18 TAG 22-no rail TAG 19 TAG 38 TAG 327 TAG 328 TAG 424 TAG 425 TAG 426 TAG 436 TAG 427 TAG 310 TAG 417 TAG 368 TAG 452 TAG 385 TAG 381 TAG 281 TAG 55 TAG 448 TAG 57 TAG 406 TAG 413 TAG 15 TAG 18 TAG 22-no rail TAG 10 TAG 405 TAG 434 TAG 406 TAG 416 TAG 407 TAG 416 TAG 356 TAG 323 TAG 324 TAG 487 TAG 468 TAG 469 TAG 23 TAG 431 TAG 432 TAG 433 TAG 434 TAG 325 TAG 326 TAG 327 TAG 328 TAG 59 TAG 435 TAG 436 TAG 437 TAG 438 TAG 439 TAG 440 TAG 441 TAG 442 TAG 443 TAG 444 TAG 445 TAG 446 TAG 447 TAG 448 TAG 449 TAG 450 TAG 451 TAG 452 TAG 453 TAG 454 TAG 455 TAG 456 TAG 457 TAG 458 TAG 459 TAG 460 TAG 461 TAG 462 TAG 463 TAG 464 TAG 465 TAG 466 TAG 467 TAG 468 TAG 469 TAG 470 TAG 471 TAG 472 TAG 473 TAG 474 TAG 475 TAG 476 TAG 477 TAG 478 TAG 479 TAG 480 TAG 481 TAG 482 TAG 483 TAG 484 TAG 485 TAG 486 TAG 487 TAG 488 TAG 489 TAG 490 TAG 491 TAG 492 TAG 493 TAG 494 TAG 495 TAG 496 TAG 497 TAG 498 TAG 499 TAG 500

110.tif









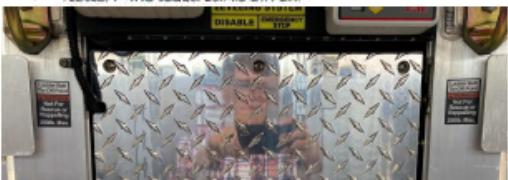

## REAR WARNING TAGS

	1	2	3	4	5	6	7	8	
A									A
B	<b>Rear, Bucket</b> <ul style="list-style-type: none"> <li>10140837 - LABEL Stokes Basket Tie-Off Point</li> </ul>						<b>Rear, Bucket</b> <ul style="list-style-type: none"> <li>10140837 - LABEL Stokes Basket Tie-Off Point</li> </ul>		
C	<b>Rear, Bucket</b> <ul style="list-style-type: none"> <li>10063859 - TAG Stokes Arm Capacity</li> </ul>						<b>Rear, Bucket</b> <ul style="list-style-type: none"> <li>10063859 - TAG Stokes Arm Capacity</li> </ul>		
D	<b>Rear, Chevrons</b> Modify the following tag: <ul style="list-style-type: none"> <li>10063871 - Tag Ladder Belt Tie Off Warning</li> </ul> As is shown in the image below by cutting below "Ladder Belt Tie Off Point" part of label						<b>Rear, Chevrons</b> Modify the following tag: <ul style="list-style-type: none"> <li>10063871 - Tag Ladder Belt Tie Off Warning</li> <li>As is shown in the image below by cutting below "Ladder Belt Tie Off Point" part of label</li> <li>10114871 - TAG Electrocutation Hazard Large</li> </ul>		
E			<b>Rear, Rear of Truck</b> <ul style="list-style-type: none"> <li>10000087 - NAMEPLATE Sutphen Logo 5m 7.875" x 3.5" w/psa</li> </ul>						
F	<b>DETAIL A</b> SCALE 1 : 12 		<b>Rear, Bucket Pivot</b> <ul style="list-style-type: none"> <li>10063856 - TAG Bucket Static Load</li> </ul>						
	1	2	3	4	5	6	7	8	



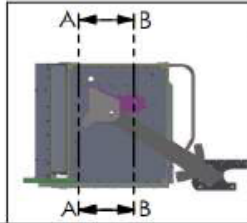



**Operator Manual**

### BUCKET WARNING TAGS

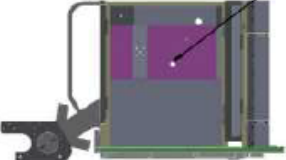
<p><b>Bucket, Rear</b></p> <ul style="list-style-type: none"> <li>10043811 - TAG Exiting Cab 3000588-024</li> </ul>  <p><b>Bucket, Control Panel</b></p> <ul style="list-style-type: none"> <li>10114347 - Bucket Levelling, E-STOP Disable</li> <li>10013892 - LABEL, AERIAL ALARMS SIZE B, 10012500 Bezel</li> <li>10012174 - INTERLOCK OVERRIDE SIZE B BLACK, 10012500 Bezel IF APPLICABLE</li> <li>10134891 - LABEL, BREATHING AIR ALARM</li> </ul>  <p><b>SECTION A-A</b> SCALE 1 : 20</p> <p><b>Bucket, Rear</b></p> <ul style="list-style-type: none"> <li>10043871 - TAG Ladder Belt Tie Off Point</li> </ul>  <p><b>Bucket, Rear</b></p> <ul style="list-style-type: none"> <li>10011833 - TAG 125V 15A 1PH or C BLACK ON SILVER, 10012500 Bezel</li> <li>10011889 - TAG CFI breaker or C BLACK ON SILVER, 10012500 Bezel</li> </ul> 	<p><b>Bucket, Rear</b></p> <ul style="list-style-type: none"> <li>10063811 - TAG Exiting Cab 3000596-024</li> </ul>  <p><b>SECTION B-B</b> SCALE 1 : 20</p> <p><b>Bucket, Control Panel</b></p> <ul style="list-style-type: none"> <li>10063858 - TAG Lifting Eye Capacity</li> <li>10063754 - Platform Equipment 300103-0001</li> <li>10114870 - TAG Electrocutan Hazard Size A</li> <li>10114869 - TAG Fall Hazard Restraint Required</li> <li>10114876 - TAG Trained Operator Required</li> <li>10114872 - TAG Failure Do Not Exceed Capacity</li> <li>10063700 - Aerial Rappel Warning 301033-001</li> </ul>   <div style="text-align: center;">  <p><b>SUTPHEN CORPORATION</b></p> <p>720 WEST WASHINGTON</p> </div> <table border="1" style="width: 100%; border-collapse: collapse; margin-top: 5px;"> <tr> <td style="width: 60%;">DOCUMENT NUMBER</td> <td style="width: 20%;">BY</td> <td style="width: 20%;">PAGE</td> </tr> <tr> <td>SPH_Labels</td> <td>A</td> <td>9 OF 10</td> </tr> </table>	DOCUMENT NUMBER	BY	PAGE	SPH_Labels	A	9 OF 10
DOCUMENT NUMBER	BY	PAGE					
SPH_Labels	A	9 OF 10					

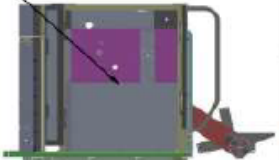

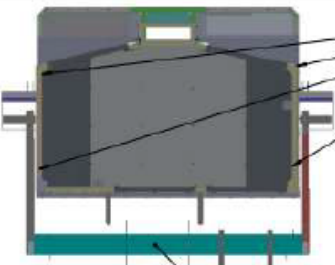
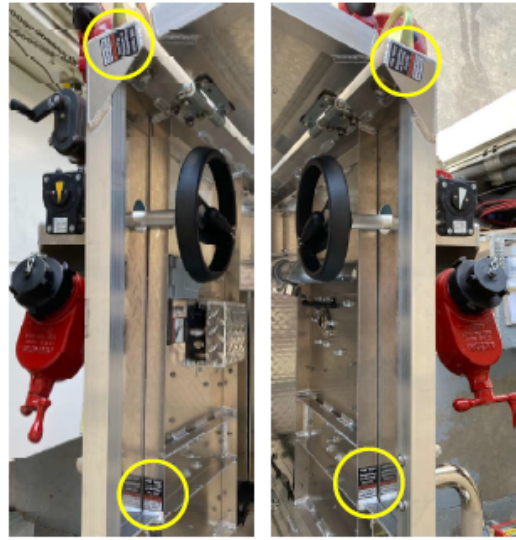
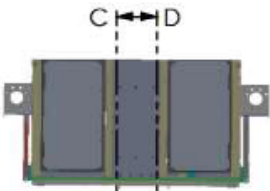
## BUCKET WARNING TAGS CONT'D

1	2	3	4	5	6	7	8
A	BUCKET WARNING TAGS CONT'D						A
B	<p><b>Bucket, Officer Side</b></p> <ul style="list-style-type: none"> <li>10117474 - TAC Manual Override, 10012479 Bezel</li> <li>10063702 - Levelling System Override 3000598-0031 Bezel</li> <li>10063704 - OPEN VALVES FALL HAZARD 300056-0028 Bezel</li> </ul>  			<p><b>Bucket, Driver Side</b></p> <ul style="list-style-type: none"> <li>10012269 - WATER CURTAIN SIDE B BLACK</li> </ul>  			B
C	<p><b>Bucket, Top</b></p> <ul style="list-style-type: none"> <li>10043871 - TAC Ladder Bail Tie Off Point</li> </ul>  						C
D							D
E	<p><b>Boom, Ladder</b></p> <ul style="list-style-type: none"> <li>10114875 - TAG Pinch Hazard Moving Rungs</li> </ul> 						E
F	<div style="display: flex; justify-content: space-between; align-items: center;">  <div style="text-align: center;"> <p><small>CONFIDENTIAL AND SOLEMNLY &amp; THE CONFIDENTIAL AND PROPRIETARY PROPERTY OF SUTPHEN CORPORATION. THE USE, REPRODUCTION OR DISCLOSURE IN WHOLE OR IN PART, OF THIS DOCUMENT TO ANY PERSON WITHOUT WRITTEN AUTHORIZATION IS EXPRESSLY PROHIBITED. WRITING FROM WRITTEN AUTHORIZATION OF SUTPHEN CORPORATION.</small></p> <p><b>SUTPHEN CORPORATION</b></p> </div> <div style="text-align: right;"> <p><small>PROPERTY NUMBER</small></p> <p>SPH_Labels</p> </div> <div style="text-align: right;"> <p><small>REV</small></p> <p>A</p> </div> <div style="text-align: right;"> <p><small>PAGE</small></p> <p>10 OF 10</p> </div> </div>						F
1	2	3	4	5	6	7	8

**Operator Manual**

<b>REAR WARNING TAGS</b>		
Rear, Bucket	10140837 - LABEL Stokes Basket Tie-Off Point	N/A
	10063859 - TAG Stokes Arm Capacity	N/A
Rear, Chevrons	10063871 - TAG Ladder Belt Tie-Off Warning	N/A
	10114871 - TAG Electrocutation Hazard Large	N/A
Rear, Bucket Pivot	10063856 - TAG Bucket Static Load	N/A
Rear, Rear of Truck	10003087 - NAMEPLATE Sutphen Logo Sm 7.875" x 3.5" w/psa	N/A
<b>BUCKET WARNING TAGS</b>		
Bucket, Rear	10063811 - TAG Exiting Cab 3000588-024	N/A
	10063871 - TAG Ladder Belt Tie-Off Warning	N/A
	10011833 - TAG 125V 15A 1PH sz C BLACK ON SILVER	10012500
	10011889 - TAG GFI breaker sz C BLACK ON SILVER	10012500
	10063858 - TAG Lifting Eye Capacity	N/A
	10063754 - Platform Equipment 300103-0001	N/A
	10114870 - TAG Electrocutation Hazard Size A	N/A
	10114873 - TAG Pinch Hazard Moving Rungs	N/A
	10114876 - TAG Trained Operator Required	N/A
	10114872 - TAG Failure Do Not Exceed Capacity	N/A
	10063700 - Aerial Rappel Warning 3001033-001	N/A
Bucket, Control Panel	10114349 - Bucket Leveling, E-STOP Disable	N/A
	10013892 - LABEL, AERIAL ALARMS SIZE B	10012500
	10012174 - INTERLOCK OVERRIDE SIZE B BLAC	10012500
	10134891 - LABEL, BREATHING AIR ALARM	N/A
Bucket, Officer Side	10117674 - TAG Manual Override	10012479
	10063702 - Leveling System Override 3000588-0031 Bezel	N/A
	10063704 - OPEN VALVES FALL HAZAR 3000588-0028 Bezel	N/A
Bucket, Driver Side	10012269 - WATER CURTAIN SIZE B	N/A
Bucket, Top	10063871 - TAG Ladder Belt Tie-Off Warning	N/A
Bucket, Ladder	10114873 - TAG Pinch Hazard Moving Rungs	N/A



---

## 1.4 Cab Setup Procedures

### Locating the Vehicle

1. Spot the rig about 30 to 35 feet from the building when possible. This will give you maximum vertical coverage of the building.
2. Set the parking brake.
3. Place the transmission in neutral.
4. Make sure apparatus is on firm pavement, and that it is clear of overhead obstacles, such as poles, wires, building overhang, etc.
5. Make sure that the outriggers or rear jacks are not going to sit upon manhole covers, drains, or grates in the street.
6. Good judgement must be used in locating the apparatus at the fire scene. Ideal conditions may not always exist, so caution must be used to determine as safe a location as possible for the apparatus.

### Activating the Hydraulic System

There is a PTO which operates the hydraulic pump, providing hydraulic pressure to the system.

1. Engine must be at idle RPM.
2. Be sure there is at least 90 lbs of air pressure on truck air system.
3. Truck must be at complete stop, parking brake set, and transmission in neutral (N).
4. Flip rocker switch for Aerial PTO.

The cab controls are now set to operate the hydraulic system.

If not using the fire pump, or if your vehicle does not have a fire pump, proceed to **AERIAL TOWER SETUP** found later in these instructions.



Mode Button (1) and Pilot Light (2) for Generator PTO

## 1.5 Cab Setup for Fire Pump Operation

**NOTE:** See Fire Pump Manual for more detailed information.

1. Truck must be stopped and parking brake set.
2. Truck transmission must be in neutral (N) position.
3. Engine must be at idle RPM.





4. Move the pump shift lever from ROAD position to PUMP position. This is done by raising the yellow locking collar and pulling back on the lever. Notice the green PUMP ENGAGEMENT light will come on.



**Air Pump Shift**



**Electronic Pump Shift**

### **Pump Shift Lever**

5. Shift transmission to drive (D) (1-4) position. Power from the engine is now being transferred to the pump drive gear and pump impellers are turning. Observe the illuminated green OK TO PUMP indicator light next to the shift lever. The lock-up for the automatic transmission will be engaged when the transmission is shifted into drive (D). The pump shift lever will hold the transmission in the pumping gear position.

If the light is not on, the pump is not engaged. Repeat steps 1-5 and observe for pump engagement.

6. To have the pump ready for operation later, leave transmission selector in neutral (N). For pump operation, simply put transmission selector in drive (D) (1-4).

**NOTE:** Upon arrival at a structure fire or other incident where the tower is not immediately needed, but the fire pump is being used, it is a good practice to place the PTO in gear before placing the fire pump in gear. Should a need to use the tower arise, and the fire pump is being used, the stabilizers can be set, and the tower is then ready for immediate use. If the PTO was not engaged before the pump was set up, it would be necessary to slow the engine to an idle to engage the PTO, jeopardizing firefighting operations.

## 1.6 Aerial Setup Procedures

Your Sutphen Aerial Platform has been designed to work in out-of-level conditions up to 5 degrees in any direction. You can work in high winds up to 35 miles per hour.

## 1.7 Stabilizing System

This system consists of twelve double-acting hydraulic cylinders. Four of the cylinders permit the extension of the main outriggers to be located in such a manner as to allow for curbs, potholes, alleys or narrow locations between other vehicles. All cylinders are provided with double pilot-operated check valves to ensure constant holding position of any outrigger after it has been set in position. The main stabilizers (outriggers), front and rear, are provided with large steel feet that swivel to allow the them to adjust to the contour of the ground surface. Auxiliary ground jack pads are provided for the outriggers and should be used every time the tower is set up. A front jack system is provided on all models.



### **DANGER**

*Always set up the apparatus on concrete, blacktop, or gravel. Surface must be firm and solid. Soil/ground surfaces are not desirable, as the outrigger may sink into the ground causing a tipover. Soil surfaces that seem stable upon setup may erode with fire scene runoff water, thus making them unstable. Asphalt parking lot surfaces are typically thin and in hot weather may allow the outrigger to sink through, especially if the subsurface material is sand.*



## Jack Controls

1. Move to the jack controls, located in the compartment directly behind the cab on the driver's side of the truck.
2. There are eight switches for the hydraulic control valves to operate the outriggers/jacks.
3. Look at the level indicator located on the rear of the cab to see how far out-of-level the apparatus is.
4. There is a switch labeled HYD TRANSFER/UPPER POWER TRANSFER

Operator Manual

- Making sure all is clear, extend the left-hand outriggers to the maximum extension. As the outriggers start out, a warning alarm will sound and the JACKS NOT SET (2) text box on the turntable pedestal will illuminate. This indicates that the jack system is not properly deployed but will silence, and the text box light will go out, when you complete the setup procedure.



Pedestal Control Panel



6. Making sure all is clear, extend the right-hand outrigger to the maximum extension, observing the area through the large mirror provided on the rear of the cab. Although one person can perform this operation, it is safer and quicker to have someone else on the right-side of the apparatus.



**View of Right Outrigger in Mirror**

7. Remove the auxiliary ground pads from their carriers under the pump steps and place them directly under each outrigger foot.



**Auxiliary Pad Under Outrigger**



## DANGER

*Auxiliary ground pads must be placed under outrigger feet at all times. Failure to do so could cause a tipover resulting in serious injury or death and/or damage to the vehicle. Never put wood or plastic jack pads down for rear jacks; use only metal for grounding.*

8. Lower the left outriggers until they touch the auxiliary ground pad.
9. Lower the right outriggers until they touch the auxiliary ground pads. View from mirror or spotter.
10. Level the truck from side to side, if necessary, to work in a range of 5 degrees out-of-level as indicated by the green area on the level indicator on the rear of the cab. As long as the level is in the green area, you are allowed to operate.
11. Push both left and right outrigger down switches simultaneously to raise the front of the truck until the front tires clear the ground one inch. If using Hendrickson Suspension, lower the outriggers until the bulge is out of the tires.
12. Lower the rear jacks so that the tires on the front tandem axle just clear the ground. If using Hendrickson Suspension, lower rear jacks until the bulge is back in the front tires.

**NOTE: At this point, the front wheels should have come down to where they are just touching the ground. If using Hendrickson Suspension, at this point, there should be a bulge in the tires.**

If working on a surface that is not level in the longitudinal axis of the truck, use the outriggers and the rear jacks to level the truck as much as possible. You can work within 10 degrees of the longitudinal axis, as show on the level indicator at the turntable

**NOTE: Depending on whether the grade is up or down, leveling will either raise the front tires off the pavement or lower them onto the pavement.**

13. Your apparatus is equipped with cab (axle) jacks, which are two cylinders mounted to the chassis frame in the front wheelwell that push against the front axle. Push the front jack switch to fully extend them, which will isolate the front suspension.



## 1.8 Safety Pins



### Installed Safety Pin

Install the outrigger safety pins (1) only after the apparatus has been completely set up properly. The operator and his/her assistant are to show the pins to each other in the mirror before installing them.

▽ **Operator Manual**

Place the outrigger safety pins in the lowest possible hole in the outrigger jack frames. The pins must be installed per instructions as this completes the interlock system and allows power to be transferred to the upper controls.

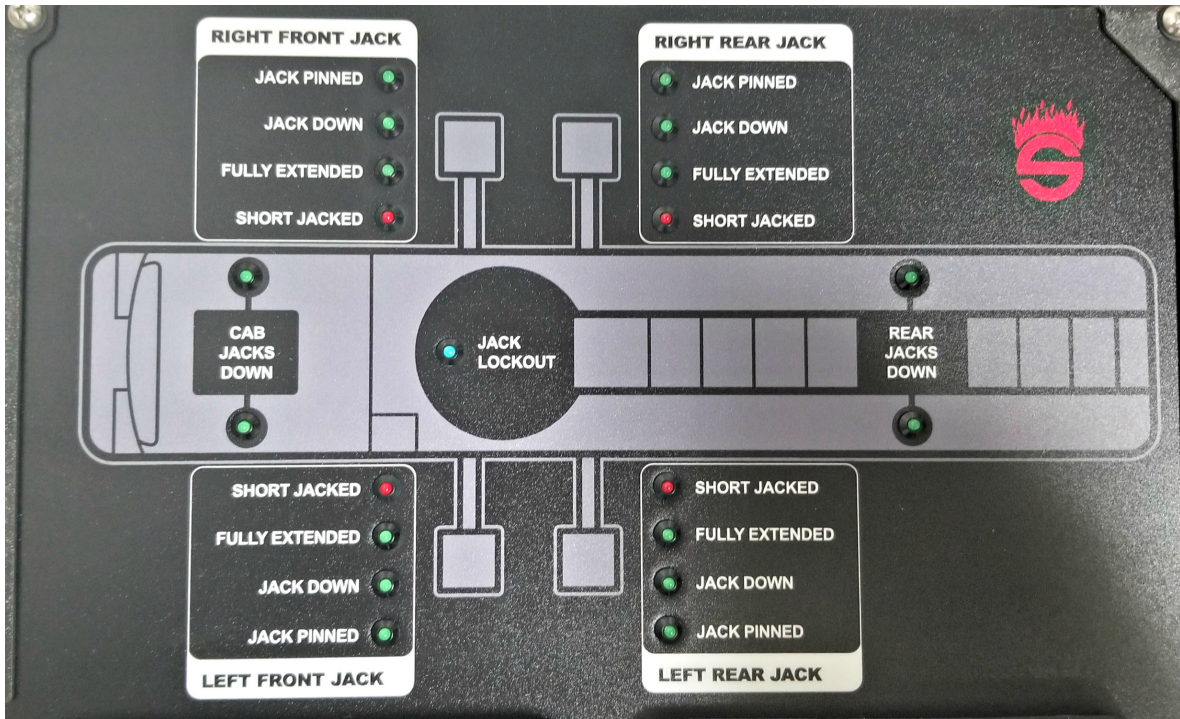

**Interlock Display Graphic**

If the safety pin hole is near (1/2 inch or less) to the safety bar, go up to next higher hole. This will avoid having the pin pinched by cylinder creep that will later not allow you to remove pin when taking down the truck. If it does happen, you must use manual controls under the rear of the cab to operate the jacks. At this point, lower the outriggers until the safety pin is free and remove it.



**DANGER**

*Always install safety pins on stabilizers. This will guard against a cylinder collapse caused by an internal leak, such as a damaged piston seal.*





## 1.9 Transfer Fluid for Aerial Operation

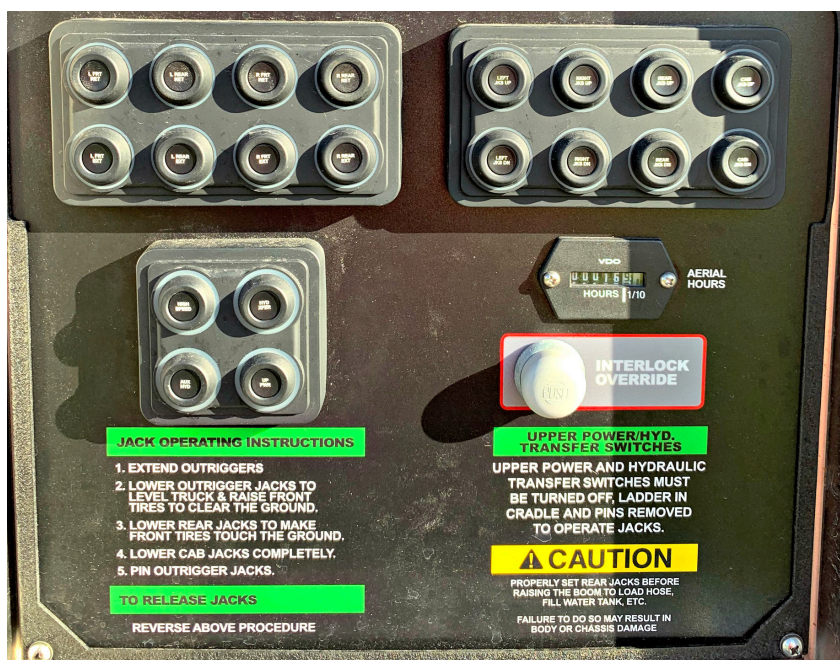

**Jack Control Panel**

Push the HYD. TRANSFER switch (1) up to the ON position. Fluid is now being pumped to the aerial controls on the turntable and the JACK LOCKOUT text box on the Ground Jack Control panel will be lit indicating the fluid has been transferred.

Activate electrical power to the turntable pedestal by turning the UPPER POWER switch (2) on the hydraulic panel to the ON position.

**SAFETY TIP:** This switch may be used to disable the platform controls should someone on the ground observe an impending danger to those in the platform that they may not be aware of.

**NOTE:** This will also shut off power to the intercom system and the platform leveling system. For this reason, it is preferred to use the Bucket Control Power switch on the pedestal, which only shuts off power to the platform and turntable controls.

**Operator Manual**

With all outriggers and ground jacks properly set as described here, your aerial is designed to operate at its maximum height and horizontal reach with its rated payload without danger of harming personnel or equipment. Precaution must be taken to ensure that the aerial is operated so it does not strike the cab or any other portion of the apparatus during any operation. Water stream reactions may have some effect on certain functions of the tower. This is detailed under Waterway and Nozzles. Power lines should always be observed and avoided at all times.



## **DANGER**

*When operating near power lines, pump operator must stand on the operator's step at all times during tower operation to help prevent operator from becoming the ground in the event tower comes in contact with power lines. Failure to do so could result in **SERIOUS INJURY OR DEATH**.*

Place wheel chocks in front of and behind the front tandem. Place the chock at the outside tires.



## **CAUTION**

*Always remove the chocks before releasing any of the ground jacks. Failure to do so may result in wedging the chock block so tightly against the tire tread that it cannot be removed.*



---

## 1.10 Stabilizer Interlock System

This stabilizer interlock system is a series of position sensors that are specifically designed to ensure safe and proper set up of the apparatus for aerial operation.

When the outriggers begin to extend, a warning alarm sounds and the JACKS NOT SET box on the pedestal operator panel lights. This indicates that the jack system is not properly set up or properly stowed. The alarm will silence and the JACKS NOT SET will go out when the jack system is properly set up or properly stowed.

When the ground jacks are set up according to the instruction previously found in this manual, one set of four sensors closes when the stabilizers are fully extended and one set of four sensors closes when the outrigger jacks have the safety pins installed. The closing of these switches produces a signal which allows the aerial to be operated.

### **Stabilizer Interlock Override Procedure**

Located on the left side of the Ground Jack Control panel and on top of the turntable pedestal are the stabilizer interlock override buttons. They are to be used only in extreme situations where one or both outriggers cannot be fully extended on the side opposite the side you are wanting to operate on. These buttons should be only used by personnel fully trained in the operation of the vehicle. This includes understanding the danger of an overturned vehicle caused by working over an unextended outrigger.

By simultaneously depressing the buttons, you can raise the aerial from the bed of the truck. After the aerial has cleared the bed, you may let go of the override buttons and the tower will continue to operate. Notice that when the aerial clears the bed, the audible alarm stops, but the JACKS NOT SET text box remains on, reminding you that the truck is not set up properly.

After the tower is in operation, great concern shall be given to the position of the tower and shall never be rotated past the longitudinal centerline of the truck towards the “short-jacked” side. The short-jacked side of the truck should have the outriggers run out as far as possible and have the pad down and pin in.

## **1.11 Rotation Interlock System**

The rotation interlock system will allow the aerial to operate with only two outriggers fully extended on one side and the other side only partially extended. This condition is known as short jacking. This configuration may be required when operating in very narrow areas.

All four outriggers must be lowered properly, and the safety pins must be installed properly for the aerial to operate.

In operation, the boom is permitted full unobstructed operation on the side of the fully extended outrigger. Operation is not permitted past the centerline of the truck towards the short-jacked side of the truck.

When operating over the properly jacked side of the truck, and you rotate near the longitudinal centerline of the truck, the rotation interlock system will activate audible and visual alarms and put the aerial controls into CREEP MODE. As movement continues, the rotation will stop preventing movement over the short-jacked side.

Movement will be allowed back towards the properly jacked side.

If, for some reason, the boom has drifted to the short-jacked side of the truck, the controls will allow you to rotate back towards the centerline of the truck in whichever direction is closest.



## 1.12 Smart Boom Warning System

This system will warn you both audibly and visually of impending contact with either the cab or the body of the truck. It will not stop movement of the boom!

The system consists of sensors underneath the turntable that determine the radial location of the aerial and adjustable sensors on the left turntable side plate that determine the elevation of the aerial.

Located at the turntable pedestal and in the platform are graphic displays (1) for the SMART BOOM WARNING SYSTEM and the ROTATION INTERLOCK SYSTEM. They provide visual indications of the current status of aerial operations.

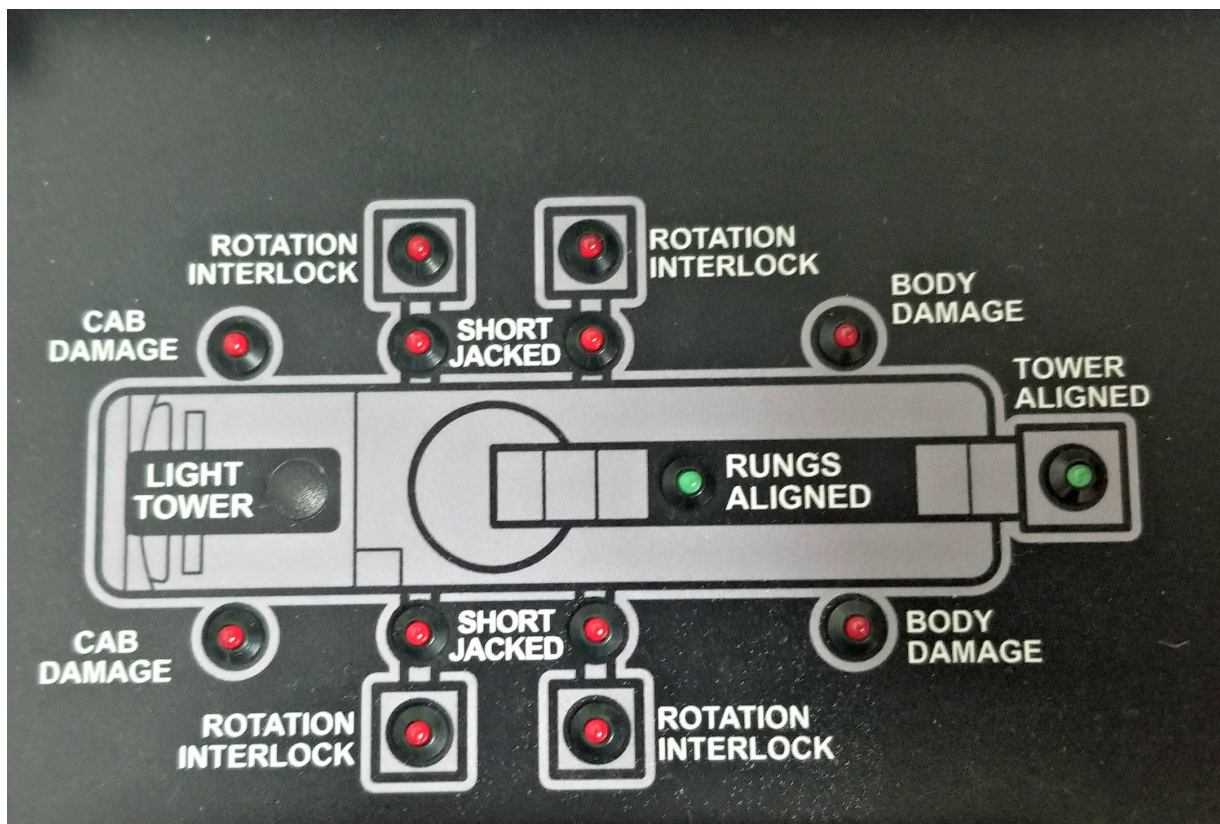

**Pedestal Display Panel of Smart Boom Warning System  
and Rotation Interlock System**



### Bucket Control Panel

In operation, if the boom is positioned above the cab or body and is lowered to a point that the SMART BOOM WARNING SYSTEM is activated, the aerial controls will be put into a slow motion CREEP MODE and visual and audible alarms will be activated. The aerial controls will remain in CREEP MODE as long as the boom is inside the CONTACT ZONE.

If the boom is in a low elevation over one of the outriggers and is rotated toward the cab or body, the SMART BOOM WARNING SYSTEM will be activated when in close proximity.

When in a CREEP MODE, full operational speed may be regained by either elevating or rotating the boom until it is clear of the CONTACT ZONE.

When a CONTACT ZONE alarm is sounding, you may cancel the audible portion of the alarm by pushing the ALARM SILENCE button. This will cancel it at both operators' stations. When the boom is moved to a location outside the CONTACT ZONE, the audible alarm will be automatically reset.



## 1.13 Aerial Operational Controls



Pedestal Controls



Platform Controls

**Operator Manual**

The aerial may be operated from the turntable pedestal controls (1) or the platform controls (2). The platform and pedestal controls are multiplexed electric-over-hydraulic.

You will notice that both sets of controls are “proportional”, meaning that the operations can be “feathered” to produce gentle movements.

The pedestal controls will always override the platform controls. If the platform operator is moving in one direction, the pedestal operator can stop the operation if an emergency need arises. The power to the platform controls can be turned off at the pedestal or in the ground jack controls.



## **DANGER**

*Never operate the tower without first deploying the stabilizer jacks with proper auxiliary ground pads beneath them.*

### **Raise/Lower**

Raise the tower by moving the right control lever in the direction indicated.

Lower the tower by moving the right control lever in the direction indicated.

**NOTE: Controls in platforms are duplicates of lower controls.**

When raising the tower from the cradle, the first motion of the tower should be up, and this should continue until tower is well above the truck.



## **CAUTION**

*Observe that tower has cleared the truck body, cab, and lights before rotating. The recommended procedure for aerial operation is a slow, steady movement of the control lever which will produce a smooth operation.*



## **CAUTION**

*Rapid movement or jerking of the control levers will result in rough jerking of the aerial imposing excessive loading on the tower structure. This kind of operation is unsafe and will lead to premature wear and, at the extreme, possible structure failure.*





## **DANGER**

*When raising the aerial, extreme caution should be used near power lines. The operator must observe the tower structure from base to tip to ascertain that the tower is in the clear.*

The tower can be elevated from minus 5 degrees to plus 80 degrees from the horizontal while in any position of extension and any position of rotation.



## **WARNING**

*There should be an operator at the lower control station any time the aerial is being used. The lower controls can override the platform controls should an emergency or dangerous situation come up or if the platform operator should become incapacitated because of smoke or other problems.*

### **Extend/Retract**

Extend the tower by moving the left control lever in the direction indicated.

Retract the tower by moving the left control lever in the direction indicated.

### **Rotation**

Rotate the tower to the left by moving the center control lever in the direction indicated.

Rotate the tower to the center by moving the right control lever in the direction indicated.

The tower is capable of continuous 360-degree rotation, either to the left or the right.

The operator should never change direction of rotation without first bringing the aerial to a gentle stop.

## Fairfield Drive Rotation Brake

### General Information

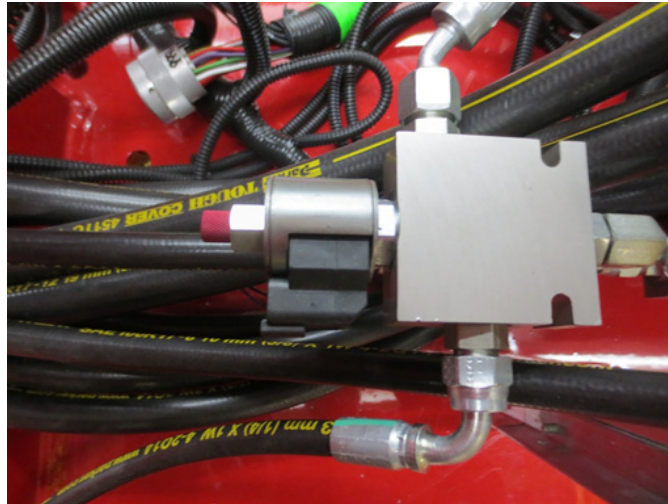

**Rotation Brake**

The brake valve is plumbed to the rotation drive motors. The purpose of the brake is to hold the aerial in position and not allow the aerial to drift during water flow from the tip of the aerial. The brake also holds the aerial in position when the truck is set up on an incline.

The brake valve is electrically actuated from the Sauer Danfoss base control module. The brake can be released to allow the aerial to rotate using the manual handles for rotation at the pedestal.

**NOTE: The brake valve must be returned to normal operation (knob "IN") when the manual rotation handles have finished being used.**



## Location of The Rotation Brake

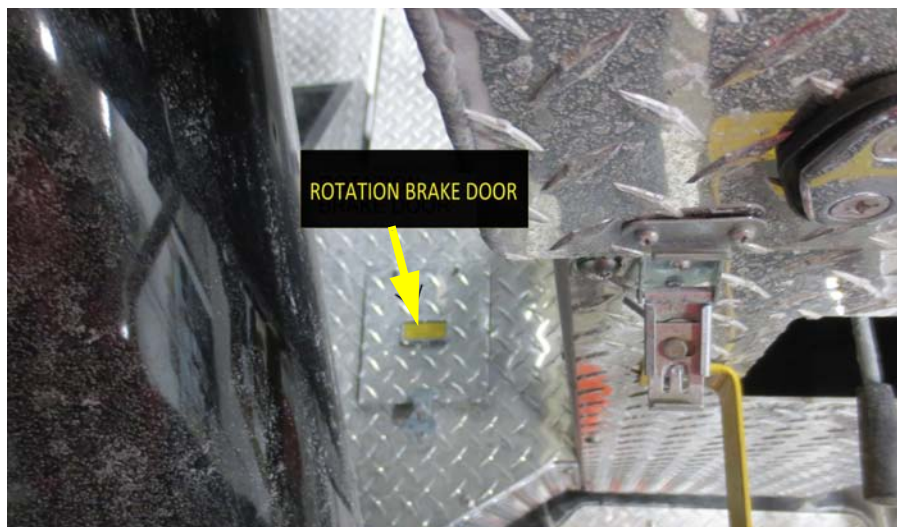

### **Rotation Brake Door**

The rotation brake is located in the tunnel next to the pedestal on the turntable. Access the brake valve knob by opening the rotation brake door.

## Releasing the Brake Valve

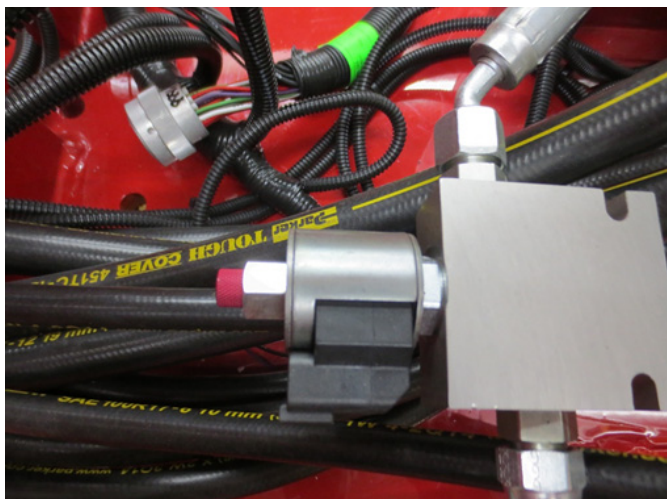

### **Rotation Brake Valve**

The photo shows the rotation brake valve in the tunnel (tunnel covers have been removed for clarity).

▽ **Operator Manual**

The brake valve has a red knurled knob on the end. Normal joystick operation is when the knob is "in". This position will not allow the aerial to drift or move once the brake is on.

To allow the aerial to rotate using the manual handle, the red knob must be "out". This releases the brake.

**NOTE: The knob must be twisted and released to pop out.**

**The knob must be twisted and pushed in to return the brake to normal operation.**

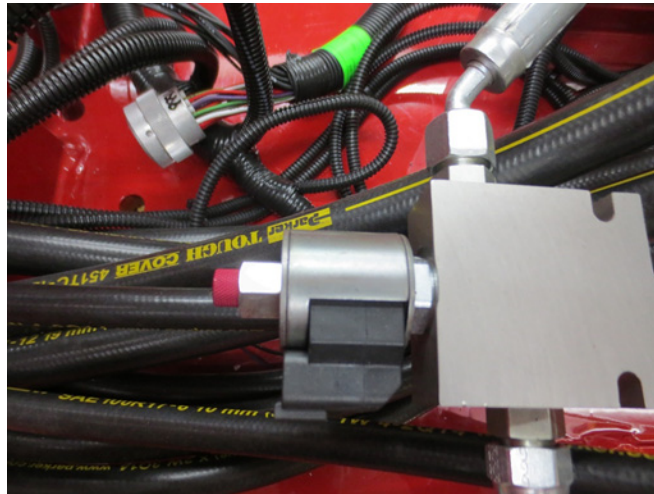

**Knob Is In: Joystick Rotation**

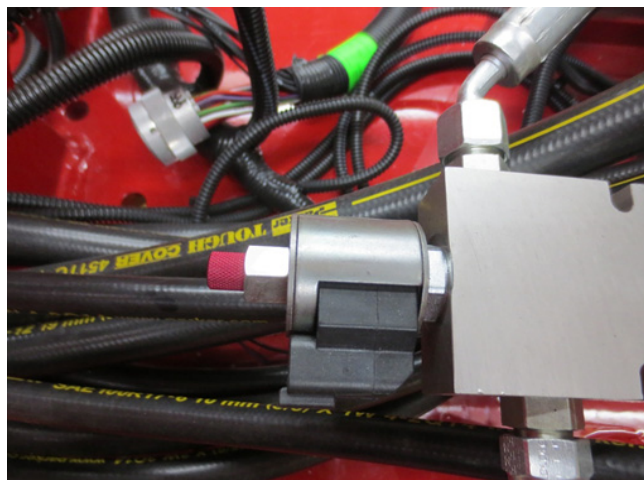

**Knob Is Out: Manual Rotation**



---

## High-Speed Control

On the floor of the turntable and on the floor of the platform there is a HI-SPEED switch provided to increase the engine speed and hydraulic pressure simultaneously. These switches are to be used only to increase the speed of operation of the aerial.

There is also a high-speed switch on the Ground Jack Control panel that may be used while operating the outriggers/jacks.



### CAUTION

*Caution must be used in the use of this HI-SPEED switch.*

**NOTE: When in pump mode, the switch is disabled.**

**NOTE: When using the HI-SPEED switch, first have the operational control lever being used in position before engaging the HI-SPEED switch. When coming off HI-SPEED, first release the switch, then release the control lever as desired to complete movement and give a smooth, safe operation.**

When extending the aerial and using the HI-SPEED control, be sure to release the HI-SPEED switch before reaching maximum extension. Aerial extension will stop at maximum extension. (There is no signal device for indicating full extension.)

When retracting the aerial and using the HI-SPEED switch, be sure to release the HI-SPEED switch before reaching full retracted position.

**NOTE: The aerial is capable of continuous 360-degree rotation to the left or right. If it becomes necessary to rotate at a faster speed, the HI-SPEED switch can be used. Be sure the rotation control lever is engaged before engaging the HI-SPEED switch. When coming off HI-SPEED, release the HI-SPEED switch before releasing the rotational control lever. This will give a nice smooth operation.**



## **CAUTION**

*While rotating the tower, the operator should not change directions without first permitting the tower to come to a complete stop!*

In the event the operator accidentally changes rotation directions without the tower coming to a complete stop, there is a built-in relief valve provided to reduce the shock of such a happening. **IN NO WAY SHOULD THIS BE AN OPERATIONAL PRACTICE!**

### **Low Range Switch**

On the platform control panel there is a switch labeled LOW RANGE. When turned on, this will slow the aerial to approximately half-speed. This can be beneficial when working near obstacles to give you precise control. When activated, both the bucket controls and pedestal controls will be affected.

### **Auxiliary Hydraulic Power Switch**

The auxiliary hydraulic power switch is located on the hydraulic panel. Auxiliary power is used in the event of a main hydraulic pump failure or in case the truck engine fails. It consists of an electric motor, operated from the truck battery system, which operates an auxiliary hydraulic pump.

Operate the motor by pushing and holding the auxiliary power switch in the ON position.

All tower functions can be operated on auxiliary power.



## **CAUTION**

*Prolonged operation may cause the motor to overheat. The operator should avoid overheating and burning out the motor. If the motor becomes hot, shut down and allow to cool. Failure to do so could result in serious damage to the motor. Run for two minutes and cool for five minutes.*



---

## 1.14 Water Delivery System

### Telescopic Waterway

The waterway through which water from the pump or manifold assembly is transferred to the nozzle is a five-section, telescopic aluminum device. It is located within the tower sections mounted and cushioned to eliminate any undue stress or strain under tower operating conditions.

The waterway is fed from the pump through the main feed line, coming up through the turntable and passing through a large stainless steel flex tube, which is directly attached to the waterway. Special packing gland seals are provided at the attachment location of each waterway section to ensure constant alignment and eliminate wear to the tubes.

The feed line for the waterway is provided with an electric ball valve at the lower entrance of the water supply. For best results, open and close valve at idle pressure. This is to ensure that no undue water surge is applied to the waterway. A manual override for this valve is provided in the left-rear outrigger opening. There is a hex nut that can be used to open the valve.

**NOTE: This override turns clockwise to open.**

Two relief valves are installed in the waterway system to help prevent excessive pressure in the waterway (one under the truck and one just behind the platform). Should the operator retract the tower without opening the waterway drain or should pump pressure exceed the capacity of the waterway, the relief valves will open. The lower relief valve is set at 250 psi discharge pressure, and the upper is set at 165 psi. The waterway drain should always be left open when tower is not being operated.

Maintenance is minor and is described in the section under lubrication.



## CAUTION

*Before retracting the tower, make sure that the nozzles and the waterway drain are open to avoid compressing the water in the waterway. Failure to do so can result in serious damage to the waterway.*

### Platform Water System

There are two turrets with adjustable stream nozzles provided on each side of the platform attached to the supporting yoke assembly. Gear-drive butterfly valves are installed ahead of the turrets to allow smooth control of the water coming to the turrets, eliminating the possibility of surges (water hammer) through the waterway system. The water system is rated for up to 2000 gpm. The rating in the bucket, while waterway is charged or flowing water, is 500 lbs.

Both nozzles may be operated simultaneously or individually. The nozzles are rated to deliver the capacity of the turrets.

There are auxiliary connections on the water system at the platform for standpipe operations. They are 2 ½ inches with a 1 ½-inch reducer and cap. They are controlled by closing the butterfly valve on the turret; then controlling the water flow of these connections with the gate valve ahead of the hose connection.

### 1.15 Draining the Fire Pump

Open all master and individual drain valves (suction and discharge) and open all valves, removing caps to make sure they drain completely.

Drain gauges on tower gauge panel.

When pump is completely drained, all individual drains may be shut, but the master drain should be left open until the fire pump is needed to be used.





## 1.16 Cold Weather Operations

### Draining the Waterway



**Truck has Automatic Drain  
Valve on Yoke**

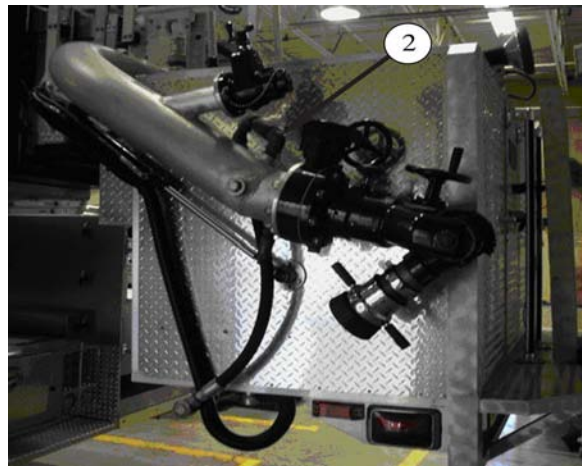

**Water Curtain Valve**

If operating with your aerial flowing water during freezing conditions, these instructions must be followed for draining the waterway to help prevent potential freezing.

Immediately after shutting off the water flow to the waterway, open the nozzles 50% in the platform, the water curtain (2), and the waterway drain valve (1) (at the pump panel). To expedite the draining process, retract the aerial completely and elevate as high as practical.

If there is ice buildup on your aerial caused by overspray, you should rotate your boom left and right before retracting. This will help break the ice before stowing.



### **CAUTION - Cable Track System**

Constant or at least frequent extension and retraction during icing conditions can reduce the possibility of ice forming. Never operate the the ladder when ice has clearly formed or may have formed inside the cable track. Damage may occur if ice builds up inside of the cable track. Ice must be allowed to melt to avoid damaging the cable track system.

▽ **Operator Manual**

## 1.17 Platform Mounting and Leveling System

The platform is suspended in the yoke, anchored on each side with special self-aligning bearings and special high-tensile steel bolts. The bolts that hold the bucket to the yoke have special locking devices to ensure positive, safe operation.

The platform is maintained in a level position relative to the turntable at all times. This is accomplished by a self-contained electro-hydraulic system, eliminating any hydraulic lines up the tower. This system operates the hydraulic leveling motor. The pivot point of the platform is above the center line of the platform, providing a pendulum effect, reducing the energy required to level the platform. The system is electrically activated and kept level during any function of the tower. The pendulum effect of the platform will keep the platform level. This is an exclusive safety feature of this aerial.

### Leveling System Override

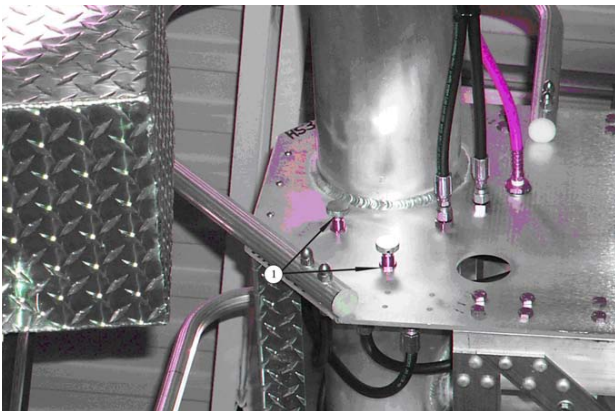

SP 110/SPI 110/ SAI 110 Leveling System Override



SPH 110/112 Leveling System Override

### Leveling System Override Valves

In case of failure, there are two needle valves (1) located on the right-side of the end of the boom. Open these valves 1/4 of a turn and the hydraulic cylinder will operate with the weight in the platform, thus keeping the platform level.



---

## 1.18 Optional Breathing Air System

On the aerial platform, a life support breathing system is installed. This consists of a 4500 psi, 6000 psi or 7000 psi air cylinder mounted in brackets on the turntable, a shutoff valve, and a constant flow air regulator.

Air is piped from the regulator by a heavy-duty air hose through a cable track located in the platform.

In the platform, there is an air filter, and two air connections are provided. There are boxes mounted on the platform to store masks in when not in use.

Air to the mask can be regulated from the air supply cylinder by presetting the regulator at approximately 120 psi. (Refer to air mask manufacturer's recommendations). Once the air pressure regulator has been set, all that is required to provide air to the platform is to turn air on at the air cylinder valve. The air valve should always be turned off when not in use. An air drain valve is provided on the bottom of the filter and should be opened briefly and periodically to expel any moisture which may be captured in the filter. This should be done with the air system turned on. Use and care of the air system should follow departmental procedures and guidelines.

Located at the pedestal and platform are low air warning devices. They will sound an audible alarm when breathing air pressure is low. Personnel using the air should move to a nonhazardous area when the alarm sounds.

There is a silence button located on the platform control station and one located on the pedestal control station that will temporarily silence the platform alarm or the pedestal alarm. The alarm will automatically sound after two minutes, when silenced, if the air is still low.

## 1.19 Climbing Aerial or Using as an Escapeway

Extend or retract the aerial slightly until the RUNG ALIGNMENT LIGHT is on, indicating that the rungs of the ladder are aligned, where one section overlaps another, making it easier to climb.

When climbing the tower or when escape procedure is in progress, the UPPER POWER switches in the platform and at the turntable pedestal should be turned off, so as not to accidentally move the tower in any way.

## 1.20 Rappelling

Sutphen Corporation does not approve rappelling from any portion of the aerial device as we cannot control the impact loading implied upon the aerial by the sudden decelerations associated with this procedure. The lifting eyes are tie-off points for static loads associated with rescue operations.

## 1.21 Loading Hose

When loading hose in the main hosebed, it is helpful to raise the boom slightly.



### **CAUTION**

*Survey the area for overhead obstructions before raising the aerial.*



### **CAUTION**

*Never rotate the aerial off to the side of the vehicle during this operation unless the outriggers are fully deployed.*

Before raising the aerial, set the front and rear jacks properly to provide stability to the truck and to transfer the force of bedding the boom to the ground. To raise the boom out of the bed, use the interlock override button on the top of the pedestal and at the hydraulic control panel.



## 1.22 Aerial Take-Down Procedures

### Stowing the Aerial Device

1. Retract aerial fully by moving the appropriate lever in the direction indicated.



### CAUTION

*Before retracting the aerial, make sure that the nozzle and waterway drain are open to avoid compressing any water in the waterway. Allow waterway time to drain before retracting the tower. Failure to do so can result in serious damage to the waterway. Point both nozzles down to minimize the chance of being hit during travel.*

2. Rotate the aerial to the left or right until it is properly aligned and the alignment light is lighted. The aerial is now in position to lower into the support cradle.
3. Lower the aerial until it reaches the cradle, making sure the alignment light is still on before actually entering the cradle. The throttle must be at idle when actually entering the cradle area.



### WARNING

*Bedding the aerial at any speed other than idle may damage the vehicle.*

4. After the tower is lowered into the cradle, continue to hold the control lever in the lower position a few seconds, then release the lever to permit a pilot check valve in the hydraulic circuit to trip and lock at its preset pressure. This locks the tower in the cradle for travel. This procedure works the same at either the controls at the pedestal or in the platform.
5. Turn control power switches off and exit the platform or pedestal.
6. Remove the wheel chocks.

**NOTE: Always remove the wheel chocks before releasing the stabilizers. Failure to do so could result in wedging the chocks tightly against the tires making them unremovable.**

7. Remove safety pins in outriggers and replace them in their holders.

**NOTE: The interlock system will not allow the oil to be transferred to the jack system until all four of the safety pins have been removed.**

8. Retract the stabilizers-
  - A. Move to the Ground Jack Controls panel.
  - B. Turn the UPPER POWER switch off.
  - C. Transfer the hydraulic oil pressure to the jack system by pushing the switch off.
  - D. Retract the stabilizers by starting with the front jacks reversing the setup procedure, moving from front-rear-outriggers up - outriggers in.
  - E. Replace the auxiliary outrigger pads in their holders after retracting the outriggers.
  - F. Push the operator's step in and lock in place with the locking bar.
9. Enter the cab and disengage the fire pump if used.
  - A. Shift transmission to Neutral (N).
  - B. Wait until speedometer registers 0 miles per hour.
  - C. Move pump shift lever from PUMP position to ROAD position.
10. Disengage the PTO switch from ON to OFF position. Observe that the red pilot light goes out.
11. Release parking brake.
12. Place transmission in appropriate gear [Drive (D)1-4 or Reverse (R)].



## **CAUTION**

*Before driving away, the operator should make a quick inspection trip around the truck to make sure all tools and appliances have been removed and stowed, compartment doors are closed, and that the vehicle is unobstructed.*

Operator must also check the five warning lights on the dashboard marked UPPER POWER, JACKS OUT, JACKS DOWN, CAB DOOR OPEN, and COMPARTMENT DOOR OPEN, making sure they are not lighted.



## **WARNING**

*All personnel must be seated and seat belts fastened before unit is moved.*



## **WARNING**

*Never back the truck unless a guide has been placed at the rear of the truck, giving clear signals to the operator. If the guide disappears from view, the movement must be stopped until the guide reappears.*

Operator Manual

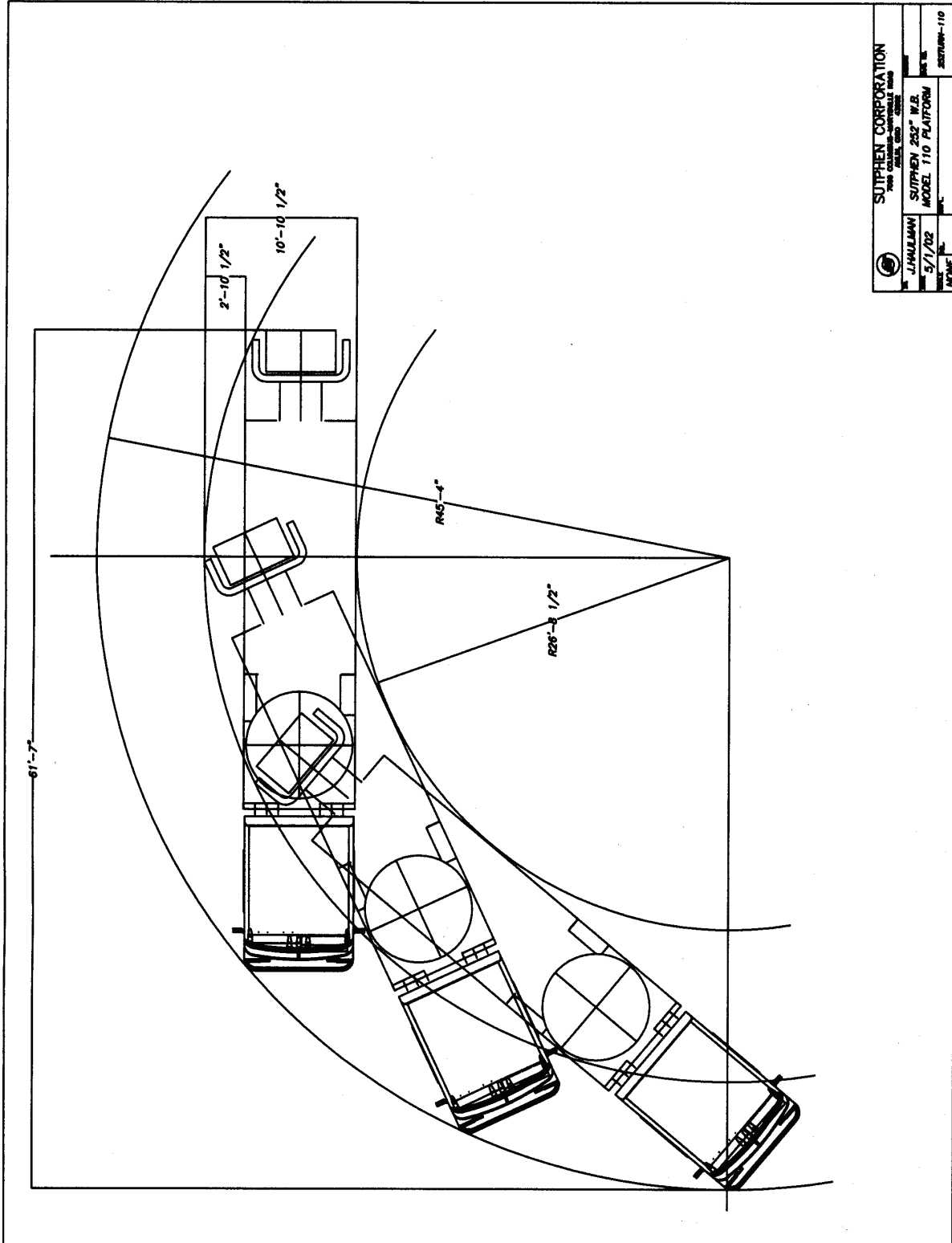



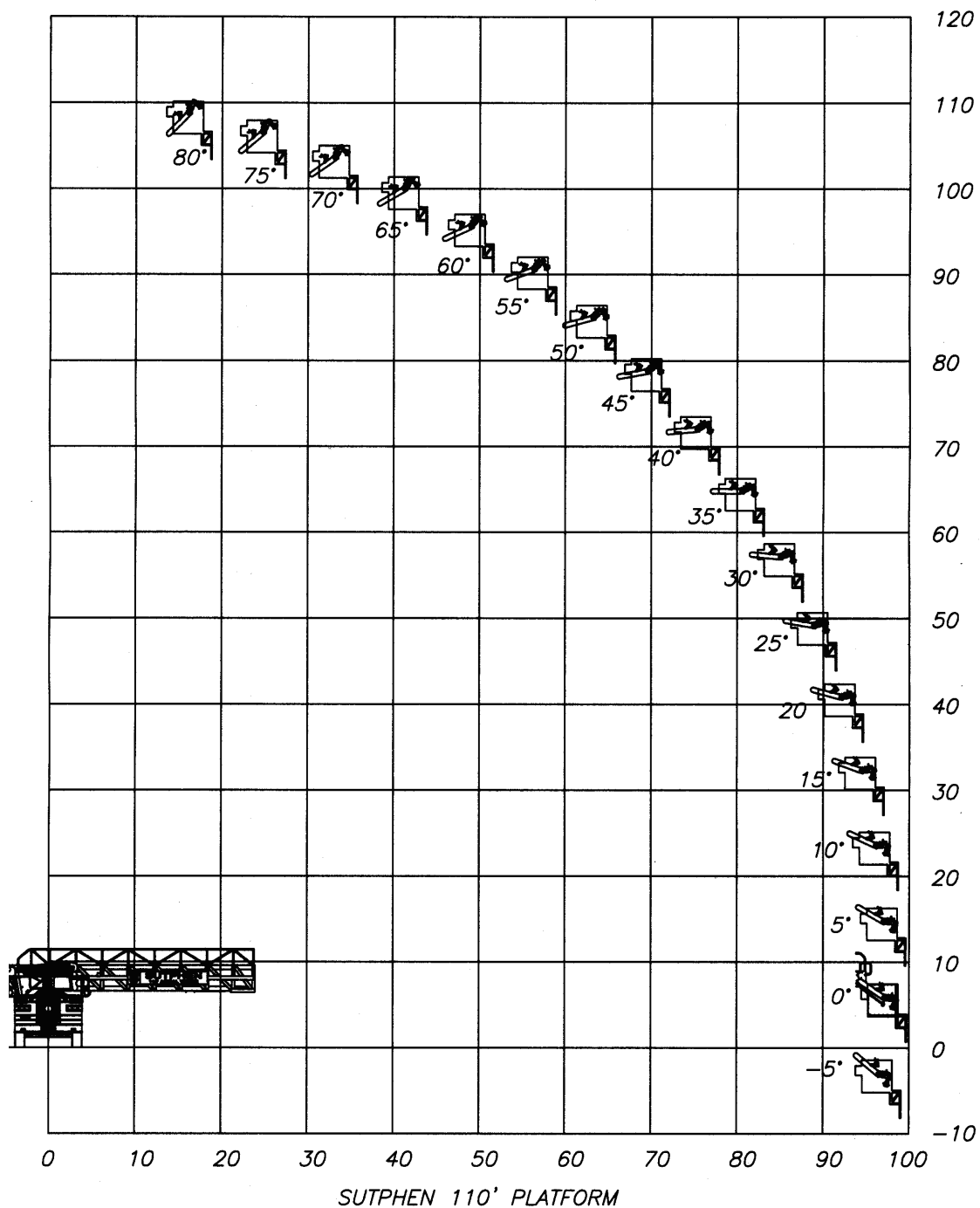





---

## Chapter 2 Maintenance Manual

	<u>Page</u>
2.1 Aerial Maintenance .....	2-3
<i>Outrigger Beams</i> .....	2-3
<i>Main Lift Cylinders</i> .....	2-3
<i>Pivot Shaft Bearings</i> .....	2-3
<i>Turntable Bearing</i> .....	2-3
<i>Fairfield Drive</i> .....	2-4
<i>Aerial Extension/Retraction Cylinders</i> .....	2-6
<i>Sheaves and Cables</i> .....	2-6
<i>Cable Adjustment Procedure for</i> <i>SPI 110, SAI 110, SPH 112 and SP110</i> .....	2-7
Before Extending Aerial .....	2-7
<i>Slide Block</i> .....	2-19
Lubrication .....	2-19
Description .....	2-19
Daily Preventative Maintenance (PM) .....	2-19
Slide Block Replacement.....	2-20
Before Beginning .....	2-20
Standard Operating Procedure .....	2-21
Periodic Preventative Maintenance (PM) .....	2-23
<i>Cable Track</i> .....	2-24
Maintenance .....	2-24
<i>Waterway and Seals</i> .....	2-26



**Maintenance Manual**

	<i>Hydraulic Oil Tank</i> .....	2-27
	<i>Hydraulic Oil Tank Fill Procedure</i> .....	2-28
	<i>SP 110 Fitted with KFS 4682 Hydraulic Reservoir</i> .....	2-29
	<i>Fuel Tank</i> .....	2-31
2.2	Maintenance of Structure .....	2-31
	<i>Aluminum Tower Structure</i> .....	2-31
	<i>Attachment of Support Structure to Truck Frame</i> .....	2-31
	<i>Aerial Tower &amp; Ice Build Up</i> .....	2-31
2.3	Sutphen-Recommended Torque Schedule for Various Fasteners .....	2-32
2.4	Daily/Weekly Walk-Around Check for Mobile Fire Apparatus .....	2-37
2.5	Draining & Winterizing Trucks .....	2-41



---

## 2.1 Aerial Maintenance

### Outrigger Beams

Ride on plastic guides - No lubrication required.

### Main Lift Cylinders

Plastic bushings - No lubrication required.

**NOTE: There are four Allen screws used as locking pins to secure the rod eye to the ram cylinder. These Allen screws should be checked and re-tightened at this time.**

### Pivot Shaft Bearings

Located on the top of the upper assembly side plates are two pivot shaft bearings, one on each side, which rotate on the pivot shaft. The pivot shaft is attached permanently to the turntable side plates on the outside of the side plates. There are grease fittings installed on the pivot shaft bearings. These bearings should be lubricated with approved lubrication/grease every 25 hours of operation.

### Turntable Bearing

This bearing and drive gear assembly is located directly under the turntable. The entire turntable and tower assembly rotates on this bearing. This bearing is pre-lubricated at the factory with the approved lubrication/grease. Two grease fittings are provided on the top of the bearing accessible through the turntable openings, one each side of the turntable. Lubrication should be done once per year. Use the approved lubrication/grease. To grease the bearing, have one person apply the grease, while another rotates the aerial one revolution or 360 degrees.

**NOTE: At this time, we recommend that all the bolts attaching the turntable to the bearing, and all the bolts attaching the bearing to the main frame should be checked for tightness. They should be checked at 175 ft/lb of torque.**

**Maintenance Manual**



**DANGER**

*Person operating the turntable for bolt alignment must make sure that all persons and tools are free and clear before rotating.*

The drive pinion gear and the turntable bearing gear have been lubricated with a special permanent elastic lubricant designed to last the life of the unit.

**Fairfield Drive**

The turntable is equipped with a rotating mechanism consisting of two hydraulically powered, planetary gear boxes (Fairfield Drives) that provide rotation for the boom. The power operated turntable provides continuous rotating of the aerial structure clockwise or counter clockwise, thus enabling the boom to be positioned in any segment through 360 degrees. The rotating mechanism also provides sufficient power to rotate the aerial sections in any direction at any angle, fully extended, while carrying the rated load capacity with the waterway in operation and discharging water at the tip of the aerial fly section.

A brake system is incorporated into the Fairfield drives and is capable of holding the turntable in a stationary position regardless of the angle or extension of the aerial, while carrying the rated load capacity with the waterway in operation and discharging water at the tip of the aerial fly section.

In the event of a loss of engine power, emergency operation of the rotation system is possible through an auxiliary power unit that is capable of providing hydraulic power to safely rotate the aerial. It is necessary to release the parking brake when operating with the emergency auxiliary power unit and the manual handles at the Pedestal.

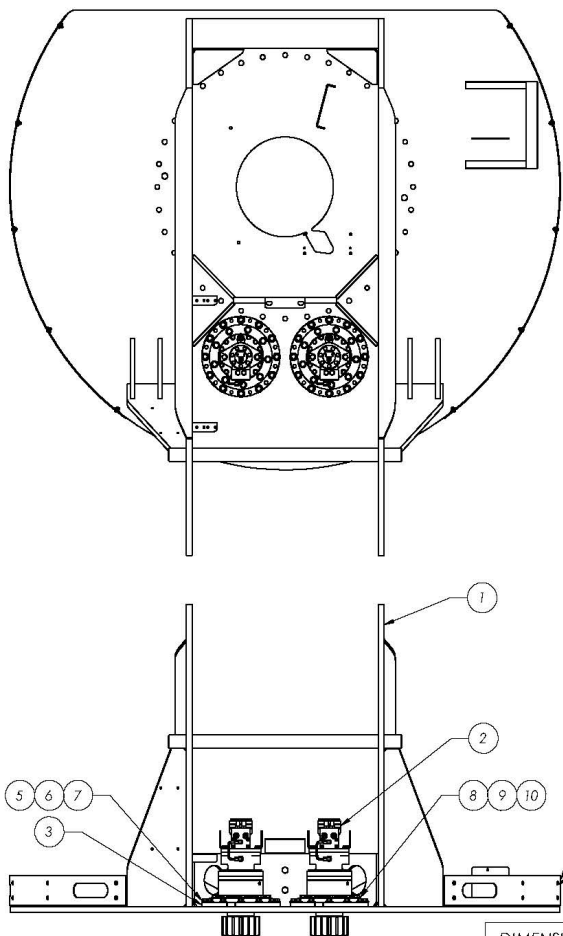

ITEM NO.	PART NUMBER	DESCRIPTION	Default/ QTY.
1	AT-C-8421	TURNTABLE WELDMENT FAIRFIELD DRIVE	1
2	AT-C-8300	ASSEMBLY - FAIRFIELD DRIVE	2
3	AT-C-8453	MOUNTING ADAPTER, ECCENTRIC RING	2
4	AT-C-8314	TURNTABLE FENCE	2
5	Regular FW 0.5	FLAT WASHER - 1/2	24
6	HFBOLT 0.5-13x2x1.25-N	HEX BOLT	24
7	REGULAR LW 0.5	LOCK WASHER - 1/2	24
8	REGULAR FW 0.5625	REGULAR FW 0.5625	18
9	REGULAR LW 0.5625	REGULAR LW 0.5625	18
10	HFBOLT 0.5625-12x1.75x1.25-N	HFBOLT 0.5625-12x1.75x1.25-N	18
11	CR-THMS 0.25-20x0.75x0.75-N	TRUSS HD 1/4-20 X 3/4 LG	20
12	REGULAR FW 0.25	REGULAR FW 0.25	20
13	LKNUT 0.2500-20-D-N	HEX LOCK NUT 1/4-20	20

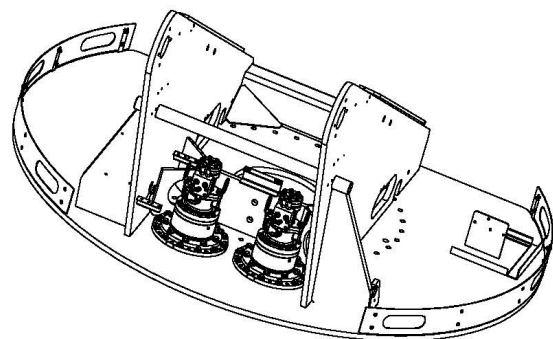

DIMENSIONAL TOLERANCES UNLESS OTHERWISE NOTED .XX = ±.06    ANGLE = ±1° .XXX = ±.031    FRACT = ±1/16 DIMENSIONS ARE IN INCHES A.0    7/25/2011    5387 REV    DATE    ECN REVISION LEVEL		MATERIAL NEXT ASSY    USED ON FIRST APPLICATION PAINT PER SHOP ORDER WEIGHT    3400.37    LBS	DESCRIPTION SPH 100 TURNTABLE ASSEMBLY FAIRFIELD DRIVE UNITS AT-C-9016 DATE    07/12/2011	CONFIDENTIAL: THIS DOCUMENT IS THE CONFIDENTIAL AND PROPRIETARY PROPERTY OF SUTPHEN CORPORATION. THE USE, REPRODUCTION OR DISCLOSURE IN WHOLE OR IN PART, OF THE DOCUMENT OR THE INFORMATION CONTAINED THEREIN, IS STRICTLY PROHIBITED WITHOUT PRIOR, WRITTEN AUTHORIZATION OF SUTPHEN CORPORATION. <b>SUTPHEN CORPORATION</b> FIRE APPARATUS SINCE 1890 6450 EITZMAN ROAD DUBLIN, OH 43016    800-848-5860
--	--	---	--	---

GENERAL NOTES: UNLESS OTHERWISE SPECIFIED  
 1. DEBURR ALL SHARP EDGES .01R OR EQUIVALENT  
 2. TAG OR INDELIBLY MARK PARTS WITH PART NUMBER AND REV LTR

## **Aerial Extension/Retraction Cylinders**

Located on each side of the first tower section is a cylinder which extends and retracts the tower assembly. There is only one point on the cylinder which requires lubrication; this being at the rod end eye mounting pin. A grease fitting is provided on the rod eye of the cylinder and should be lubricated two times per year. Use the approved lubrication/grease. At each end of the cylinder there are bolts attaching the cylinder pin to the tower. These bolts should be checked every three months for tightness.

## **Sheaves**

There are sheaves and cables which are part of the tower extension/retraction system from the second section on up. The sheaves are greaseless composite bearings that require no lubrication.

If you see a distinct, irremovable black ring around any of the sheaves, contact your local certified Sutphen service center because the sheave may need to be replaced.

## **Cables**

When servicing the cables, the tower should be extended horizontally to maximum position, and the cables wiped free of any dirt and/or grime with a slightly moist naphtha cloth and then lubricated with a thin film of Chain Mate or Vitalife 400. 





---

## **Cable Adjustment Procedure for SPI 110, SAI 110, SP110, and SPH 112**

1. Set up the truck for aerial operation as outlined in the Operator's manual.



**Truck Set Up For Cable Adjustment**

**NOTE: Be sure the waterway is empty and there is no extra weight in the platform**

2. Rotate the ladder over the side of the apparatus so the cables can be reached from the ground.

### Ladder Sections Gap

1. Check clearance between ladder sections two through five.
2. Gaps should be 1/4 inch minimum, up to 1 inch maximum.

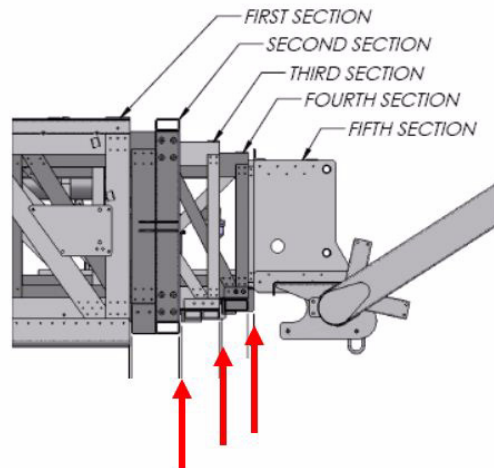

#### Fully Retracted Ladder Section Spacing

3. Check ladder sections spacing. Ladder sections should never be touching when in horizontal position. If they do touch, they need to be adjusted (sections pulled apart).

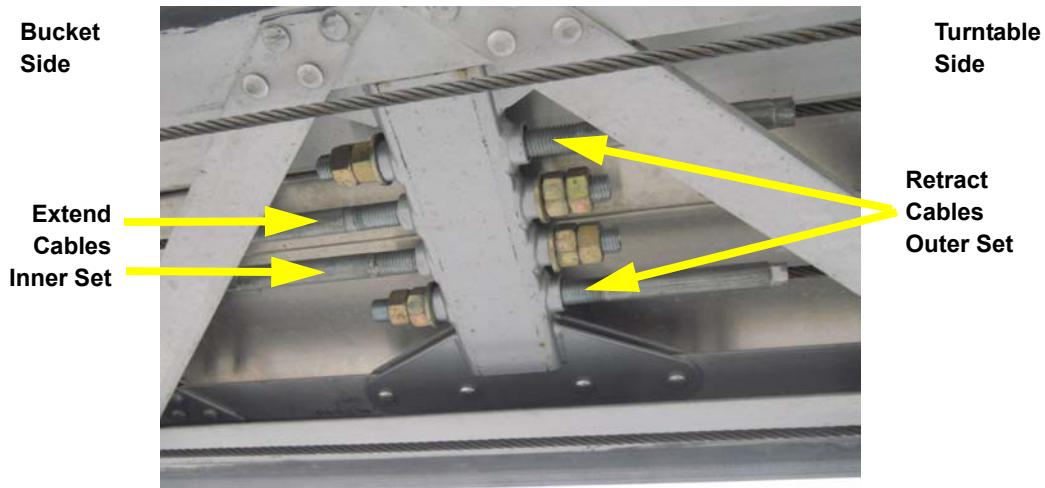

#### Extension and Retraction Cables Loosening Points

4. Set up aerial device according to the operator's manual.



- a. Rotate ladder over the side of the apparatus and position the aerial so the cables can be reached from the ground.
  - b. Make sure waterway is empty and there is no extra weight in the platform.
5. With aerial fully retracted, make sure there is a minimum of 1/4 inch and a maximum of 1 inch of gap between all ladder sections.

**NOTE: The gap between ladder sections one and two is set by the cylinder connection. This should be set at the factory and never needs to be adjusted.**



**Ladder Fully Extended**

6. Fully extend ladder out.

**NOTE: Ladder rails and waterway must be clean and properly lubricated with recommended lubrication for this aerial model before proceeding with cable adjustment.**

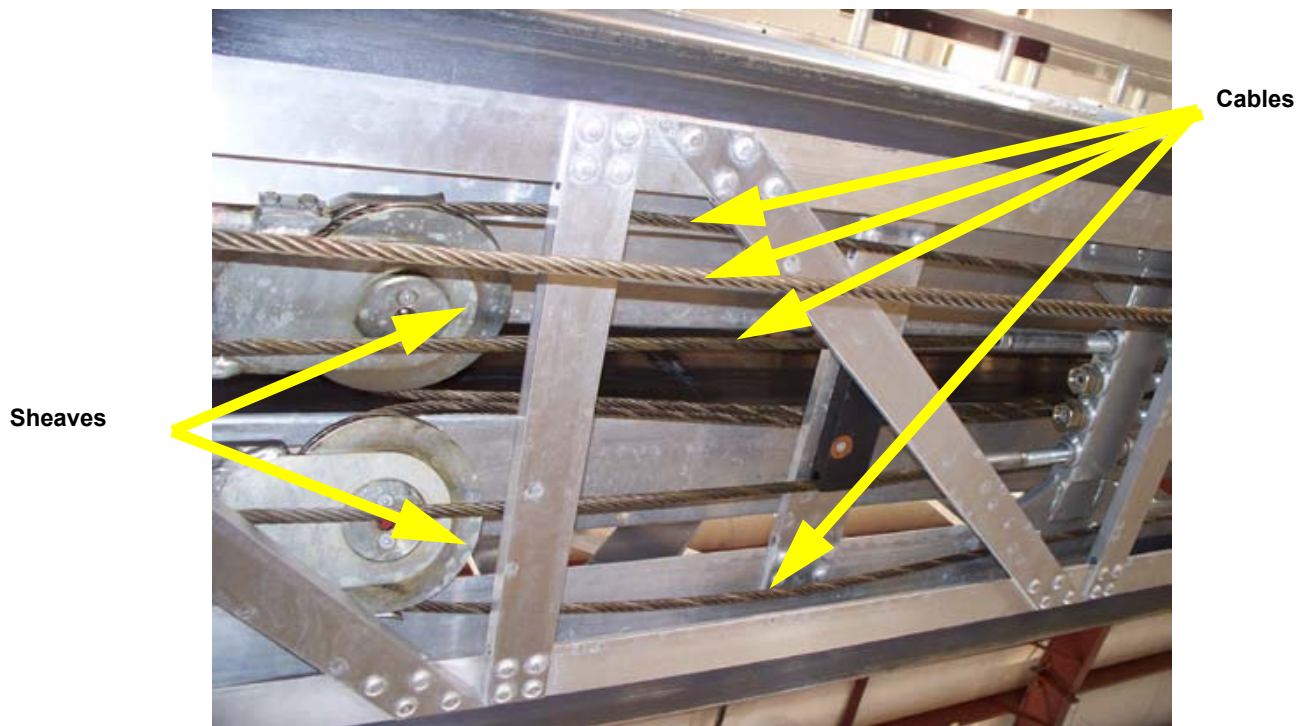

### **Cables and Sheaves**

7. Inspect cables to ensure no kinks, damage, or fraying is present and inspect sheaves to ensure there is no visible damage.



### **Cable Beam and Extend Cables Adjustment Points**

**NOTE: Retracted ladder position should now allow access to extend cables adjusting hardware.**



**Measuring Point for Other Ladder Sections**

**Center of Ladder Section Mark**

8. Take half of the measurement taken previously and mark the center of the ladder sections two, three, and four.

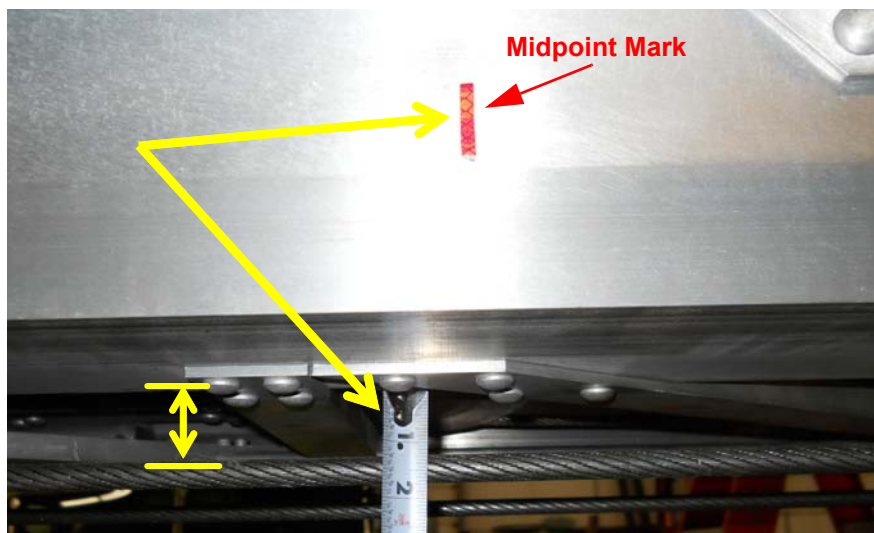

#### Measurement Areas Between Ladder Rail and Cable

12. At the mark at the midpoint (shown at red arrow), measure down to the cable.

Measurement must be:

1-1/4 to 1-1/2 inch for 1-3 cables

1-1/2 to 1-3/4 inch for 2-4 cables

1-1/2 to 1-3/4 inch for 3-5 cables

from bottom of ladder rail to top of cable.

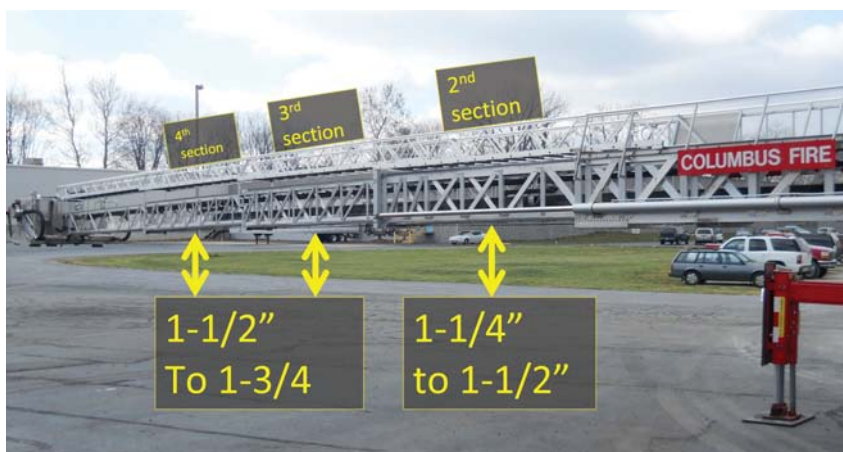

#### Bottom of Ladder Rail/Top of Cable Measurement Specifications

**NOTE:** Ladder sections and applicable measurements shown above. Measurements are taken from the center of sections two, three, and four down to the top of the cable.



**NOTE: 2" arrows indicate the maximum length the droop can be.  
If droop exceeds 2" maximum the truck is to be taken out  
of service until adjustments are made.**





### Cable Adjustment

13. Adjust cables as needed to achieve applicable measurements specified in previous steps:

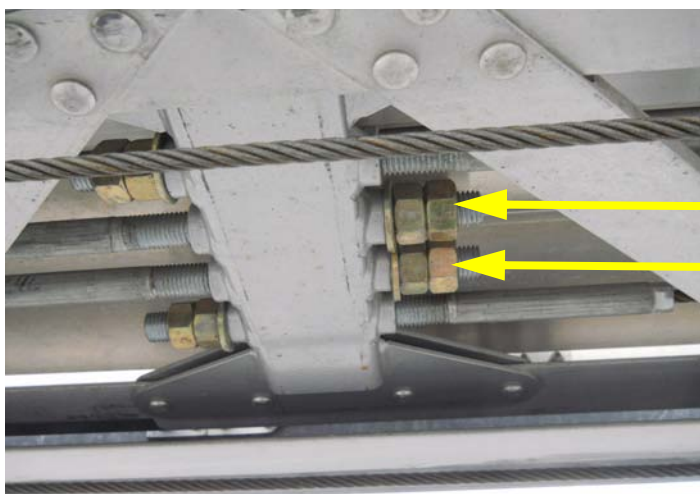

### Cable Loosening Points

- a. Loosen outer jam nuts.



**Threaded Rod**



### **Adjustment Nut and Jam Nut Tightening**

- b.** Tighten inner adjustment nut while holding steady the base of the threaded rod (close up shown in upper graphic) in order to prevent the cable from turning and possibly causing cable damage or unraveling.



**Cables Adjustment - Outer Jam Nut Retighten**

c. After cable adjustments are completed, retighten outer jam nuts.

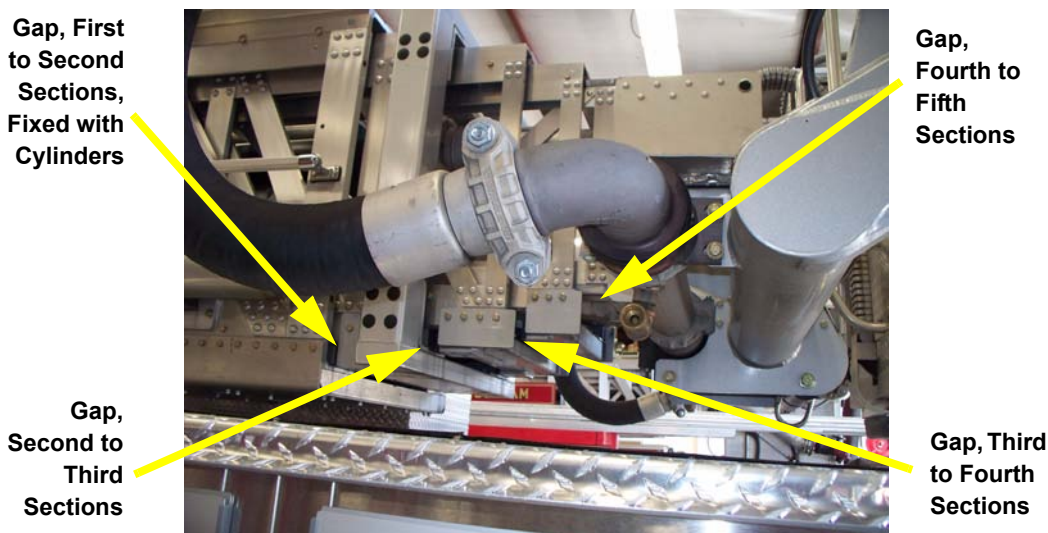

**Final Ladder Section Gap Check**

**NOTE: All adjustments are made at the horizontal position. Ladder sections may touch at vertical retraction.**

14. Fully retract the ladder and perform the final check of the ladder section gaps:
  - a. Measure clearance between ladder sections, sections two through four.



**Ladder Gap Measuring Point - Fourth and Fifth Sections**

- b. Measure clearance between ladder sections four and five.



**DANGER** *Stabilizers must be set before performing this operation.*



**DANGER**

*If any strand of the cable is fractured or damaged, immediately lower the aerial and retract slowly. Remove from service until repaired.*



## Slide Block

### Lubrication

Bill of Materials	Required Tools
Sutphen recommends:  ProOne EP-2 Grease For more information, see the email or website below: Email: <a href="mailto:info@pro-one.us">info@pro-one.us</a> <a href="http://www.pro1energy.com">www.pro1energy.com</a> To purchase ProOne EP-2 Grease email below Email: <a href="mailto:Sales@GlobalGreenLubricants.com">Sales@GlobalGreenLubricants.com</a>	Painters brush or foam brush Extended Pole for the Brush
Sutphen <b>does not</b> recommend: Use of red tacky grease as the compounds will cause the ladder to not function properly.	

### Description

Slide Blocks are the devices attached to the ends of the tower at both the upper, lower and side positions on each section. They support each section of the tower, so no metal-to metal contact can occur.

The material is a UHMW polymer compound and is designed to withstand heavy loads. Lubrication is required in the path in which the slide blocks travel on each section. The slide block paths on the aerial have been coated with a translucent white ProOne grease (see Bill of Materials above). It is available in convenient 400 gram Cartridges.

### Daily Preventative Maintenance (PM)

It is important to review the aerial slide pads and path on each section. Foreign material may become lodged between the ladder sections and the slide pads. This inevitably could cause damage to the tower. Sutphen recommends reviewing the slide pads and slide area every 25 hours of aerial use. Make sure that the sliding area has a thin coating of grease along all of the slide path areas.

**NOTE:** Within the work instruction below, you will note key quality and safety points identified with either a "Q" or an "S". Pay special attention to these items in detail for safe and quality results.

### Slide Block Replacement

When replacing slide blocks, Loctite 425 must be applied to bolt threads, and install with a maximum torque of 5 ft-lbs or 60 in-lbs. Any higher torque and the threaded inserts will spin in the blocks.

### Before Beginning



## **WARNING**

*Stabilizers must be set before performing this operation. Failure to set stabilizers before performing this procedure could result in severe injury or death.*

In order to properly lubricate the tower, extend the tower to the side of the truck and lower the boom so you can reach all sides of the aerial device.









## Standard Operating Procedure

Step No.	Q/S	Process Step Description	Associated Picture and/or Key Details
1	Q	Using a brush: Apply a liberal amount of grease in the area above and below where the vertical lacings come in contact with the long structural angles of the boom.	
	Q	Apply grease on the interior, exterior, and sides of the aerial. <b>NOTE:</b> In order to reach some of the areas within the boom, an extended pole might be needed.	

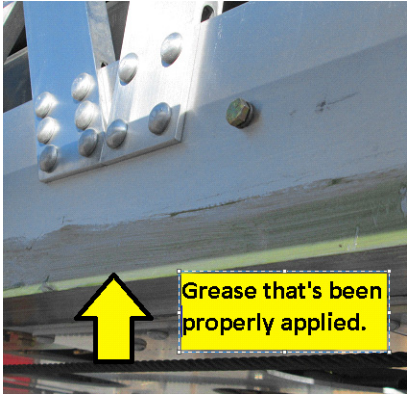
▼ **Maintenance Manual**

<p>2</p>	<p>S</p>	<p>Once all areas are properly lubricated, raise the ladder while it is fully extended to 70 degrees.</p> <p> <b>CAUTION</b>  <b>Be aware of all surroundings while lifting/ extending the boom assembly.</b></p> <p>Once the boom is raised, extend and retract the boom 5 to 6 times while at 70 degrees.</p> <p>This step will apply grease to the entire length of the aerial.</p>	
<p>3</p>	<p>Q</p> <p>Q</p> <p>Q</p>	<p>Next, bring the aerial back to the position in which it was while originally applying grease, extended off to the side of the truck.</p> <p>Review all slide block paths to make sure the grease is applied evenly.</p> <p>A correctly greased ladder section should resemble the one shown to the right.</p> <p>If you find areas where grease is missing or the slide path appears dry, apply additional product to that area.</p>	 





---

## Periodic Preventative Maintenance (PM)

Periodically, the ladder will need to be steamed-cleaned or pressure-washed to remove the grease material and then new product applied. Depending on the aerial usage hours, operating conditions and age of the existing grease, and the amount of time between thorough cleanings, will vary. A clean film of grease is always the best application for the aerial, so if any area becomes contaminated with debris, metal shavings, etc., it is recommended that you again remove the existing product and apply new.

There are exceptions to this schedule that should be considered. Should the tower be operated at a fire and exposed to excessive dirt and grime, we recommend that the slide block travel paths be cleaned and the tower be coated. Do not overcoat. A medium film of ProOne grease in the path of the slide block travel is adequate.

Do not clean your aerial using any cleaning agents or solvents that can cause chemical degradation to plastic slide blocks or other parts made from the same UHMW material.

Cleaning agents or solvents containing the following chemicals should not be used: chlorine, benzene, toluene or any compound with a Ph over 10 (i.e., sodium hydroxide).

Use of agents containing the above chemical will void your warranty due to the fact that it may cause surface cracking of the UHMW plastic material.

## **Cable Track**

The cable track should be inspected, maintained and cleaned after each use.

### Maintenance

- The cable track assembly used on aerial ladders consists of the cable track containing the cables in the boom for electrical controls and the supporting cable troughs. Both the cable track and the cable troughs must be cleaned on a regular basis to maintain proper functionality. Cleaning must be done at least annually, or sooner, if debris is found in the cable track or troughs.
- Inspect the cable track and troughs for debris after the aerial has been used on scene during fire fighting, or if it is suspected debris may have fallen into the ladder from trees or other objects while driving. Otherwise, it is recommended to inspect after 25  hours of operation.
- To clean the cable track assembly, the vehicle must be set up for aerial operation to facilitate cleaning. Refer to this operator and maintenance manual for the proper procedure for setting the jacks and operating the aerial.
- Once the jacks are set, position the ladder over one side with the ladder fully extended and the platform touching the ground.
- Check for debris and remove any if found.
- Do not use solvents or detergents of any kind to clean the cable track or troughs. Clean the cable track and troughs with water using a hose no larger than 1-inch diameter and do not use more than 100 psi.
- After cleaning the cable track and troughs with water, use compressed air to remove residual water and blow out any remaining debris or dust.

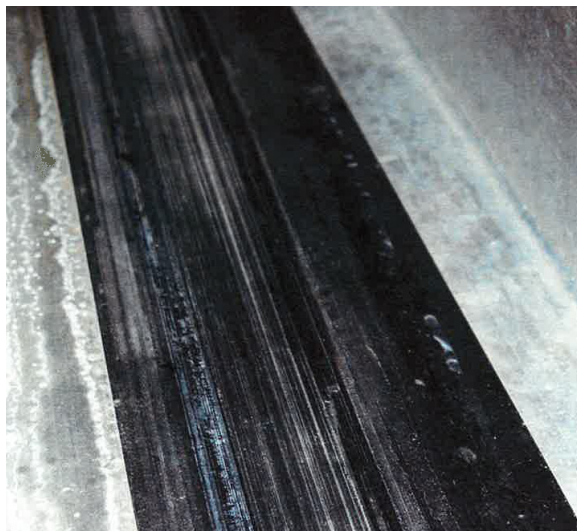

- The picture above shows a cable trough that has been properly cleaned and lubricated with dry film lubrication.
- When finished cleaning, inspect the cable track for any damage or doors that may be loose or missing. Make sure all cable track doors are securely locked in place before retracting the ladder.

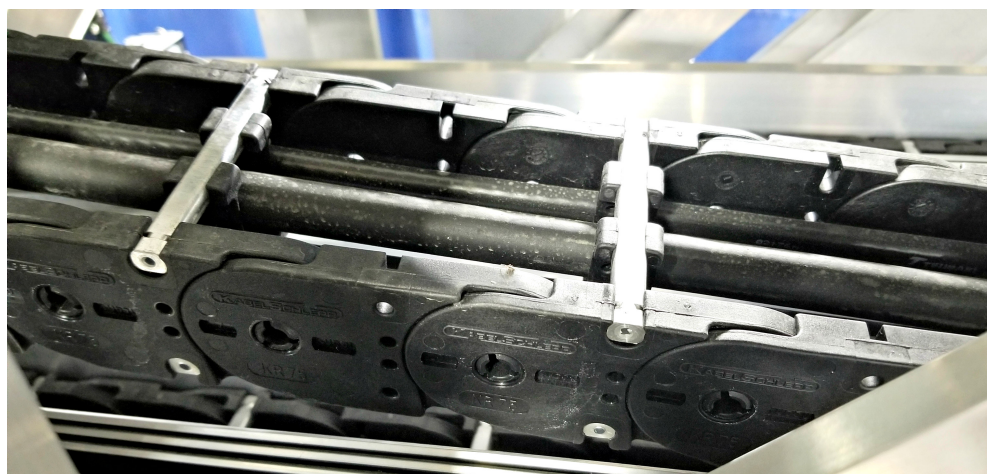

- The picture above shows the cable track with doors intact and properly locked in place.
- The ladder is now ready to be retracted, stowed, and returned to service.

## **Waterway and Seals**

This is the telescopic tube device inside the tower that carries the water to the tower nozzle. It has seals which ride on the internal honed and hard-coated surface of the tubes. These seals are made with an impregnated lubricant and should be adequately self-lubricated and cleaned by the water that passes through the waterway. However, it will prolong the life of your waterway if it is wiped off periodically with a rag saturated with Dex Merc.

The outside of the tubes are provided with nylon bearing collar assemblies built in the mounting collar of each section. The outside of the tubes should be kept wiped free of dirt and grime to protect the bearings. Should the aerial be used under extremely dirty conditions, the waterway should be wiped off before retracting to keep dirt from entering the bearings. The ladder is best accessed with it fully extended and lowered over one of the outriggers.

Consistent cleaning of the tower travel paths is the best and most inexpensive maintenance you can perform to keep the tower in perfect operation condition.



## **DANGER**

*Never extend or move the tower in any way while persons are on the tower.*

**NOTE:** The hydraulic oil tank is located behind the outriggers control panel.

### **Hydraulic Oil Tank**

Located behind the outrigger, this tank has a capacity of 65 gallons. It has a special filter screen installed. The oil level can be seen in the sight glass on the side of the tank. The hydraulic oil furnished in the tank is ATF Dex Merc.



## **CAUTION**

*When checking or adding oil, make sure all hydraulic systems are at rest (retracted). Failure to do so will result in overfilling the system.*

### HYDRAULIC OIL SPECIFICATIONS:

ANY OIL CHANGES OR ADDITIONS SHOULD BE DEX MERC,  
FILTERED TO AT-LEAST ISO 22/18/13 CLEANLINESS LEVEL.

UN-FILTERED OIL MAY ACCELERATE WEAR AND DECREASE  
PERFORMANCE OF SOME COMPONENTS.

Tag Dimensions: 3.0" height x 4.0" long

## Hydraulic Oil Tank Fill Procedure

**NOTE: Use only clean oil to fill reservoir**

1. Locate the Hydraulic Tank Fill Port behind the outrigger.
2. Check the current oil level. Proceed only if it is below the full level. If it is at, or above the full mark, the system is full.

*NOTE: you can locate the high psi filter under the cab*

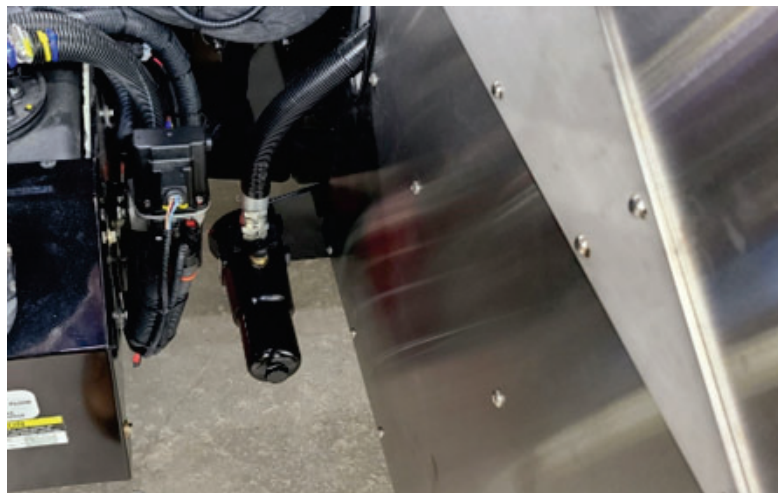
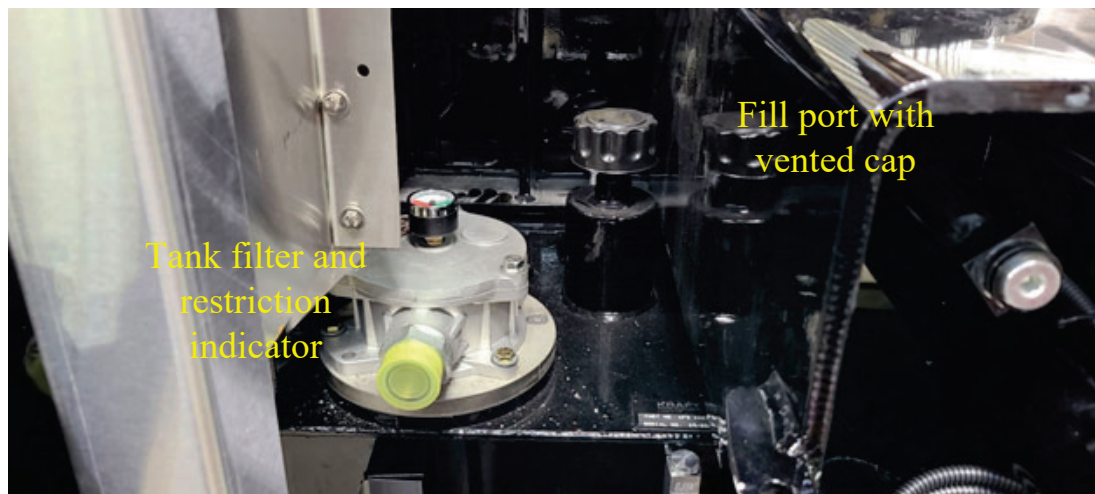



---

## **SP 110 Fitted with KFS 4682 Hydraulic Reservoir**

This Hydraulic reservoir is fitted with a MP Filtri Tank Top Filter.

This hydraulic reservoir is full with all cylinders in the stowed position 3-5 inches from the top of the sight glass.

Hydraulic fluid should be changed every 250 hours of operation or once a year, whichever comes first. The hydraulic oil furnished in the tank is ATF Dex Merc.

The return filter is fitted with a by-pass indicator. Change this filter if the by-pass indicator is going into the red. This must be observed when the unit is in operation. With the unit fully set up at high idle, observe the by-pass indicator. When running at high idle, retract and lower at the same time. This is the highest flow rate the filter will see. Otherwise, change this filter after the first 50 hours of operation and 250 hours thereafter.

Please replace with MP Filtri original equipment element # MF1801A06HB.

When checking the high-pressure filter, the hydraulic system must be in operation with multiple functions being performed (for example: extend, lower, or retract ladder). If the indicator on the filter housing is in the green zone, the filter is good. If the indicator on the filter housing is in the red zone, replace the filter. When the truck is put into service, replace the filter after the first 50 hours of operation. After that, replace the filter as needed according to the filter indicator on the housing.

Maintenance Manual

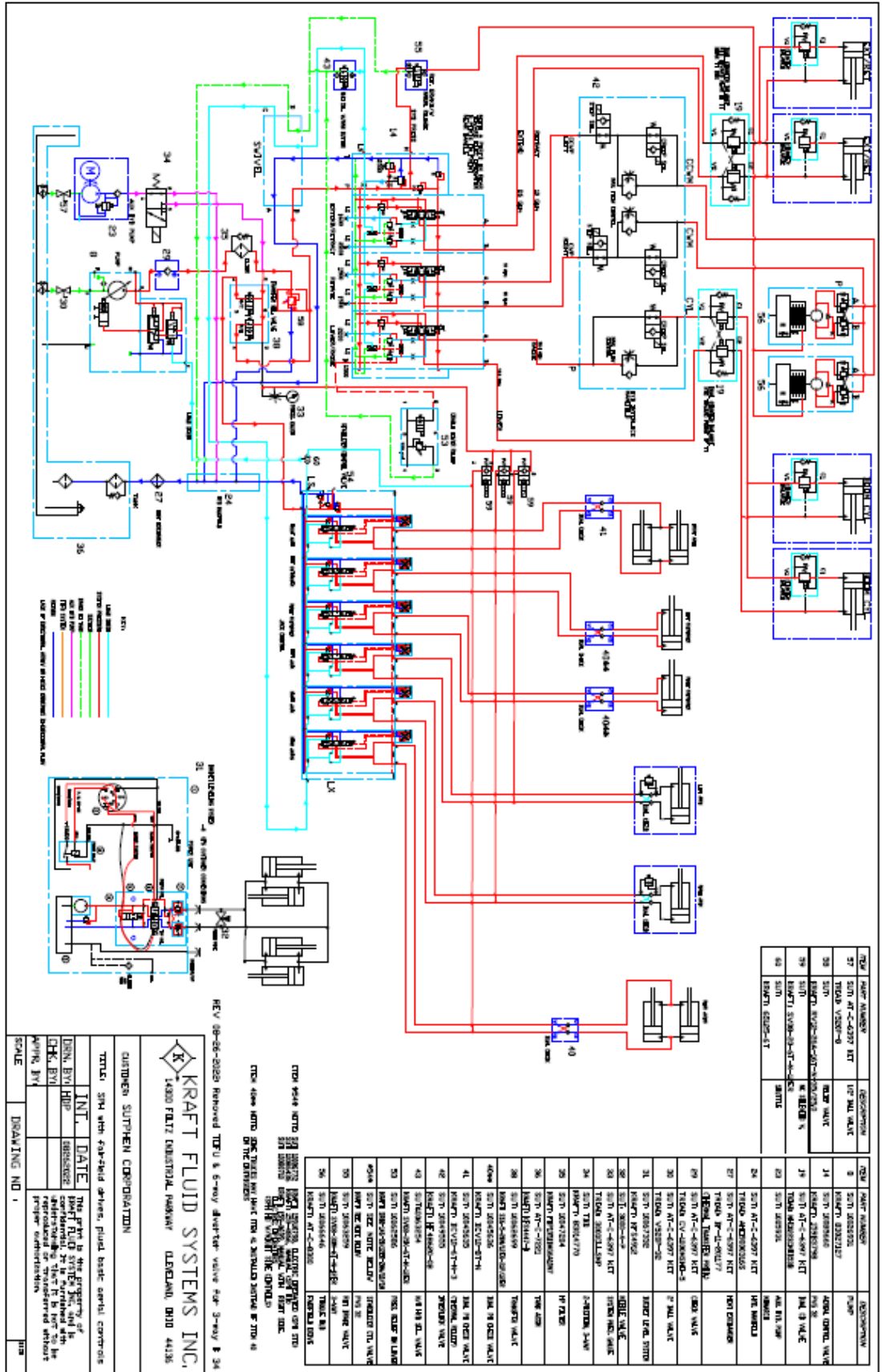





---

## Fuel Tank

The fuel tank is located behind the rear axle. It has a capacity of 65 gallons. The filler for the tank is located on the left-rear fender panel. A nameplate marked Diesel Fuel Only is attached near the filler for proper identification. Use #2 diesel fuel under normal conditions.

## 2.2 Maintenance of Structure

### Aluminum Tower Structure

The tower structure members are #6061-T6 aluminum alloy extrusion. This alloy is very resistant to corrosion and requires very little maintenance. Periodic washing with clear water only is recommended. Use mineral spirits for removal of tar, oil, and smoke film. If a brighter appearance is desired, use any quality automotive polish, a mag and aluminum wheel cleaner, or a Scotchbrite pad.

**NOTE: Sutphen recommends that once a week the ladder should be raised to full elevation, full extension, then rotated completely 360 degrees in both directions.**

### Attachment of Support Structure to Truck Frame

There are twelve Huck bolts - retorque not required.

Any indication of loosening or bolt failure should be reported to Sutphen Corporation for evaluation and disposition.

### Aerial Tower & Ice Build Up

A well lubed boom, UHMW and other non-metal surfaces will also have low stiction regarding ice. But if the conditions are optimal for ice formation and/or another aerial is being used upwind from our boom, ice will build up unless steps are taken to minimize the buildup. Including moving the boom intermittently. You still need to observe cord reel during extend or retract operations in the unlikely event ice has accumulated on the cable track.

**Maintenance Manual**

1. Raise/lower & rotate the boom to help break any built-up ice as much as possible; do not retract or extend.
2. Get up on the climbing ladder and/or rotate the boom, lower it off to one side if possible and check the cable track; you'll want to remove any pieces of ice that could cause damage.
3. Retract the boom slowly while making sure everything is moving freely without any ice and/or other debris getting bound up between the sections, cables, climbing ladders, or the trough.
4. Refrain from using tools to break the ice off-but if just needing to remove random build up make sure it's a plastic type of tool and use as little force as possible. No metal hammers or prybars.
5. Using direct flame is also a bad idea: too much plastic, cable loom/sheathing, and UHMW blocks that end up getting burnt and would then need replaced. It would be possible to use portable torpedo Oil/Kerosene heaters, extreme caution is advised, but wind could render this option useless.

## 2.3 Sutphen-Recommended Torque Schedule for Various Fasteners

See drawing for location of various fasteners.

**Section A** - Side plate pivot shaft bearings. Bolts used are 1/2" standard thread with Stover locking nuts. Torque to 55 to 60 ft/lb.

**Section B** - Pivot shaft end caps. Bolts used are 7/16" Grade 8 in tapped holes in pivot shaft with lockwashers. Torque to 35 to 40 ft/lb. End cap to side plate bolts are 7/16" Grade 8 with Stover locking nuts. Torque to 35 to 40 ft/lb.

**Section C** - Waterway support brace between side plates of boom. Bolts used are 3/4" standard thread in tapped hole on end of brace assembly. Torque to 150 to 200 ft/lb.



---

**Section D** - Pin through lift cylinder rod eye each side with securing ear. Bolts used are ½” standard thread with Stover lock nuts. Torque to 40 to 50 ft/lb.

**Section E** - Fairfield Drive for rotation. Bolts used are 5/8” standard thread with torque washers and Stover lock nuts on Fairfield Drive. Torque to 175 to 185 ft/lb. Base plate bolts are ½” standard thread with washers. Torque to 75 to 85 ft/lb.

**Section F** - Turntable bolts, top and bottom. Top bolts secure the turntable to the bearing assembly. The bottom bolts secure the turntable bearing to the turntable main frame assembly. Bolts used are 3/4-10. Torque to 225 to 250 ft/lb.

**Section G** - Curved crossplate between boom side plates. Bolts used are 3/8” grade 8 standard thread with lockwashers and nuts. Torque to 25 to 30 ft/lb.

**Section H** - Brace between boom side plates. Bolts are 3/4-10 with L-9 washer. Torque 150 to 200 ft./lb.

**Section I** - Pin through base of lift cylinder each side with securing ear. Bolts used are ½” standard thread with Stover nuts. Torque to 40 to 50 ft/lb.

**Section J** - Turntable main frame assembly secured to chassis frame rails. Bolts used are 16mm Grade 8 Huck bolts and do not require torquing.

**Section K** - Ground jack hydraulic cylinders attached to jack outrigger plates. Bolts used are 1" standard thread with Stover locking nuts. Torque to 550 to 600 ft/lb.

**Section L** - Pin through base of extend/retract cylinder each side with securing ear. Bolts used are 3/8” grade 8 standard thread with Stover locking nuts. Torque to 15 to 20 ft/lb.

**Section M** - Cross supports attached to boom assembly to support extend/retract cylinders on side of boom. Bolts used are 3/8" grade 8 standard thread with Stover lock nuts. Torque to 30 to 36 ft/lb.

**Section N** - Yoke side plates are attached to the fly section of the boom each side. Bolts used are 3/8" standard thread with Stover locking nuts. Torque to 25 to 30 ft/lb.

**Section O** - Bolt through rod eye of extend/retract cylinder each side. Bolts used are 3/4" standard thread with Stover locking nuts. Torque to 140 to 160 ft/lb.

**Section P** - Bolts that secure platform to yoke assembly. These are 3/4" standard thread special hardened bolts secured with Stover locking nuts. These do not require a full torque rate, as they are locked in place by the pivot bearing attached to the platform. Torque to 50 to 60 ft/lb.

**Section Q** - Rear jack cylinder U-bolt nuts, snug. Do not overtighten.

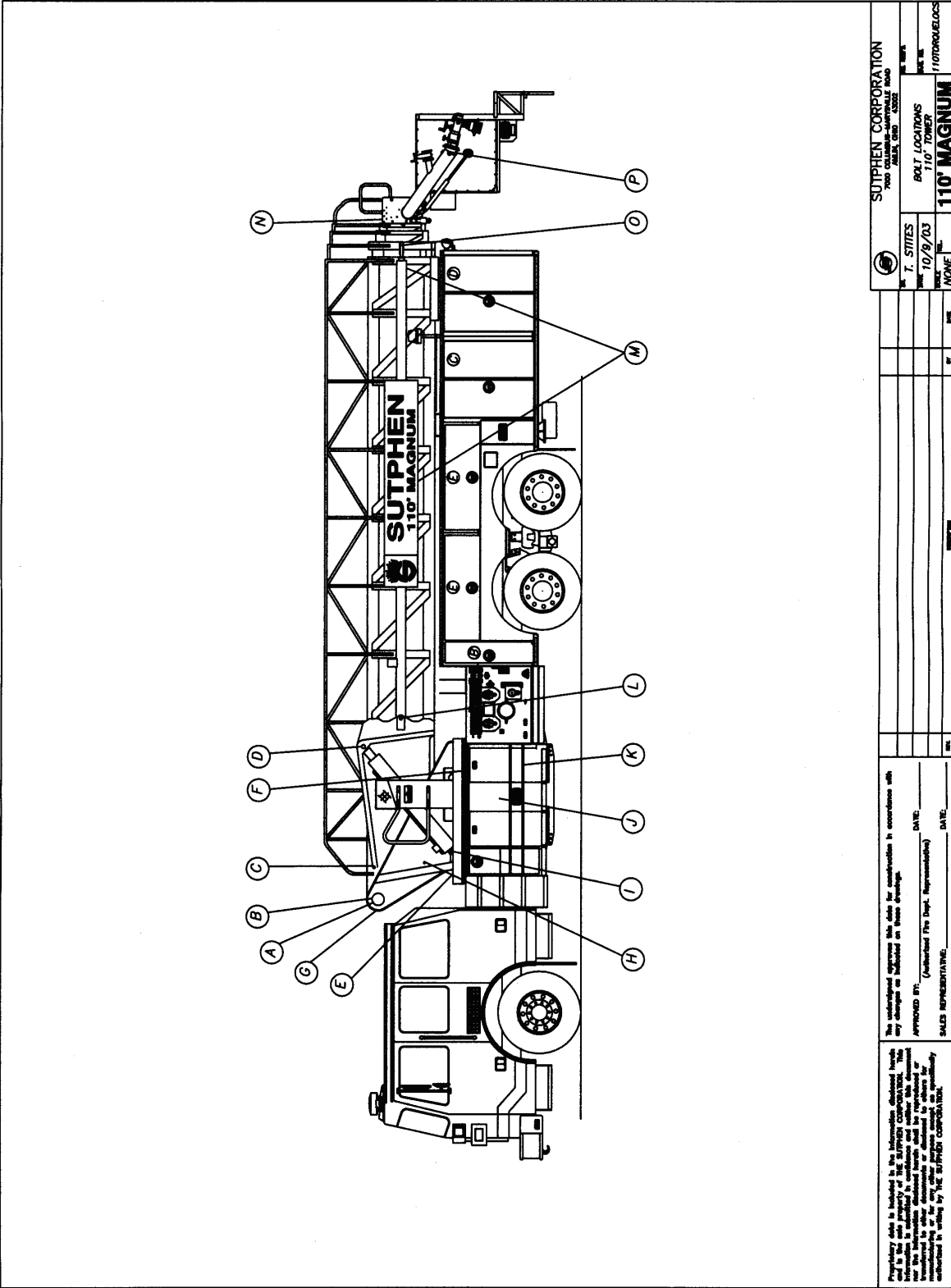

<p><b>SUTPHEN CORPORATION</b> 7000 COLLEGE-COURTWAY ROAD JACKSONVILLE, FLORIDA 32216</p>		<p><b>BOLT LOCATIONS</b> 110' TOWER</p>		<p><b>110' MAGNUM</b></p>	
<p>BY: T. STITES</p>	<p>DATE: 10/9/03</p>	<p>NO.:</p>	<p>REV.:</p>	<p>1/10/00/06/05</p>	<p>SCALE:</p>
<p>APPROVED BY: (Authorized Flr Dept. Representative)</p>	<p>DATE:</p>	<p>SALES REPRESENTATIVE:</p>	<p>DATE:</p>	<p>NO.:</p>	<p>REV.:</p>
<p>The undersigned approves this plan for construction in accordance with any changes or indicated on these drawings.</p>					
<p>Proprietary data is included in the information disclosed herein and is the sole property of SUTPHEN CORPORATION. The use of this information disclosed herein, and by reference or otherwise, in any other project without the written consent of SUTPHEN CORPORATION is prohibited.</p>					

**Maintenance Manual**

**(R) PICTURE FRAME, LOWER ASSEMBLY**

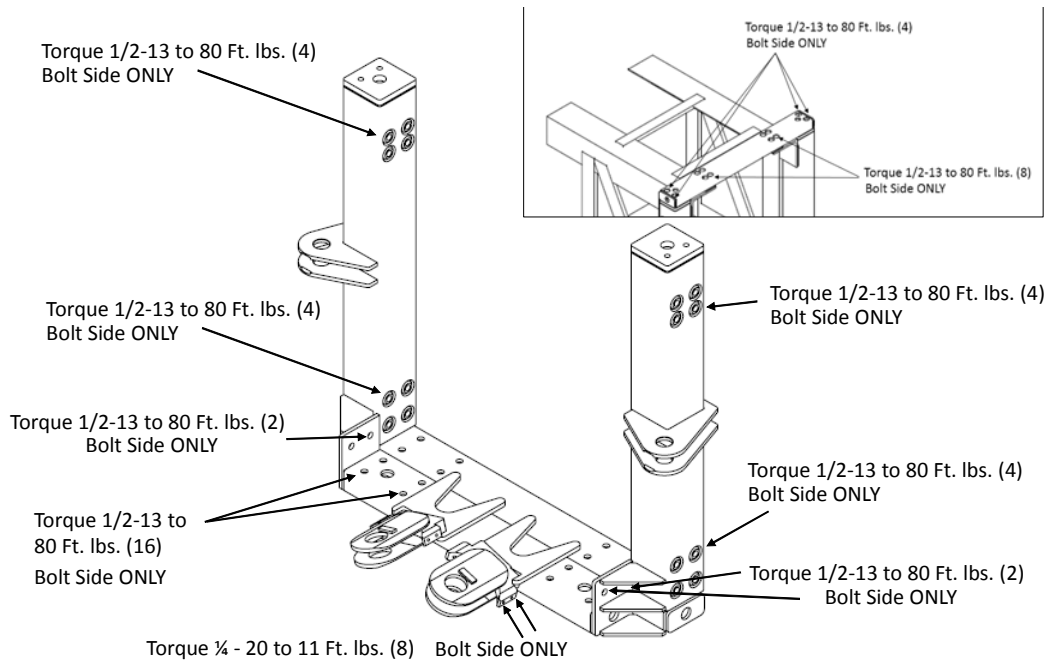

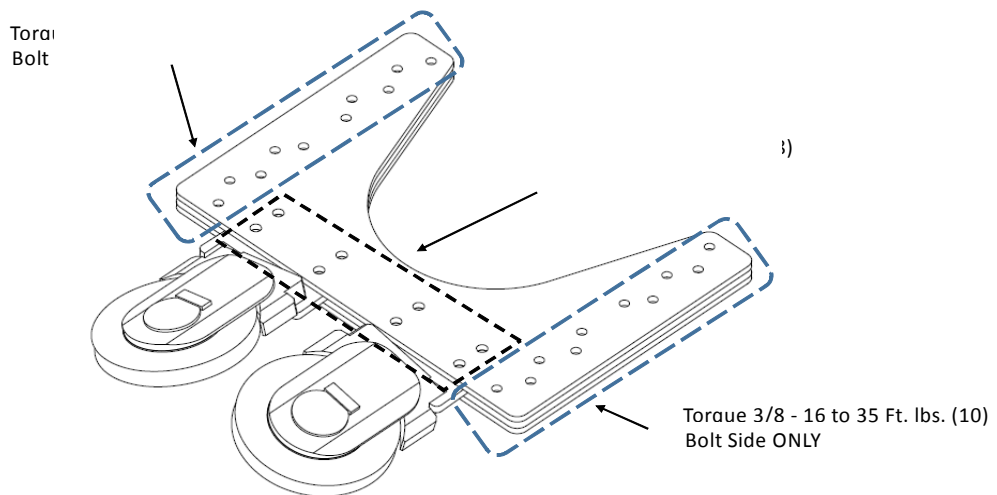

**(S) SUPPORT ASSEMBLY, LOWER SECTION 2**



**DAILY/WEEKLY WALK-AROUND CHECK  
FOR MOBILE FIRE APPARATUS**

Fire Department Name: _____	Date: _____	Inspector's Name
Truck Model: _____	HS#: _____	Monday: _____
Truck Number: _____	Station #: _____	Tuesday: _____
Start Mileage: _____	Start Engine Hours: _____	Wednesday: _____
End Mileage: _____	End Engine Hours: _____	Thursday: _____
		Friday: _____
		Saturday: _____
		Sunday: _____
Legend: X = OK		
R = Repair required (r equires a comment regarding problem)		

OPERATIONS	Daily	Weekly	Mon	Tue	Wed	Thur	Fri	Sat	Sun
<b>Engine - Tilt Cab - Make sure safety prop is engaged.</b>									
1. Check engine oil and transmission level. Check for leaks (see manual).	X								
2. Check engine coolant level- sight glass. Check for leaks.	X								
3. Check for integrity of frame and suspension, as well as motor assembly and mount. Check for loose bolts.		X							
4. Check power steering fluid level and look for leaks at fitting or hoses. Transynd		X							
5. Check belts for tightness and wear.		X							
6. Check steering shafts.		X							
7. Check for exhaust leaks. Check heat shields are in place.		X							
<b>Outside</b>									
1. Check for fluid leaks under vehicle.	X								
2. Check steering shafts and linkages.		X							
3. Check wheels and lug nuts for tightness.		X							
4. Check tire condition. - Tread Depth. (wear/damage)		X							
5. Check tire air pressure.	X								
6. Verify all warning label and placards are in place (see manual).		X							
7. Check driveline U-joints and slip joints. Lubricate if necessary. Check for tightness on all universal bolts. Visual check.		X							
<b>Cab - lower cab</b>									
1. Check seats and seat belts (damage/warning system) and ensure working properly.	X								
2. Start engine, check all gauges, switches, and controls.	X								
3. Check windshield wipers and washer fluid level check.		X							
4. Check rear view mirrors adjustment and operation. (Right and Left)									
5. Check horn, air horn, siren, and backup alarm.	X								
6. Check all gauges for correct reading after start. Fuel Level Check.	X								
7. Check cab glass and mirrors.	X								
<b>Body</b>									
1. Check steps and running boards (damage/loose hardware).		X							
2. Check body condition (doors/latching).		X							
3. Check grab handles (hardware tight secure).		X							
<b>Electric</b>									
1. Check battery voltage and charging system voltage, 13 +VDC.		X							
2. Check all lights (ICC and warning); headlights.	X								
3. Check operation of battery charger and receptacle.		X							

OPERATIONS	Daily	Weekly	Mon	Tue	Wed	Thur	Fri	Sat	Sun
<b>Waterway</b>									
1. Check waterway system operation and alignment, and check for damage.	X								
<b>Hydraulic System</b>									
1. Check aerial hydraulic fluid level. DEX/MERC 	X								
2. Check high pressure filter under load to ensure  still in the green and not in bypass as well as return the filter		X							
3. Turn on auxiliary hydraulic power pump - check operation.	X								
<b>Turntable</b>									
1. Operate aerial hydraulics + PTO operation (check for leaks or damaged hoses). Verify Indicator Light is functional.	X								
2. Rotation	X								
3. Rotation hydraulic swivel: check for leaks.	X								
4. Check lines and hoses for leaks and cuts.	X								
5. Pivot pin bolts tight on boom to turn table pivot bearing plate (Heal Pin).	X								
6. Check manual overrides.	X								
7. Check cradle alignment light and mounting.	X								
8. Check pinion and rotation bearing (Fairfield Drive/rotation drives).		X							
<b>Turntable Components or Hydraulic Compartment</b>									
1. Safety signs		X							
2. Communication system or intercom		X							
3. Interlock systems - operational	X								
4. High-speed button operational	X								
<b>Platform/Bucket</b>									
1. Leveling cylinders, leaks and wiper seal		X							
2. Lines and hoses, cuts and leaks		X							
3. Check operation of high speed.	X								
4. Check operation of intercom system.	X								
5. Check breathing air system in platform - check for leaks and hose condition.		X							
6. Inspect monitors/turret for operation.		X							
7. Verify cab avoidance system is operational.	X								
8. Verify bucket leveling system is operational.	X								
9. Verify all accessories are secure in the platform.	X								
<b>Structural Fasteners (see manual for reference)</b>									
1. Turntable mounting bolts - visual check for tightness.		X							
2. Chassis Suspension system bolts - visual check for tightness.		X							
<b>Stabilizers</b>									
1. Check aerial outrigger operation.	X								
2. Check aerial jack and rotation interlocks for operation	X								
3. Indicator lights working.	X								
4. Jack pads in proper location and serviceable.	X								
5. Mounting bolts - visual check for tightness.		X							
6. Verify safety lock pins operation in aerial jacks and in location.	X								
7. Cylinders - check for leaks and wiper seals.		X							
8. Control valve - smooth operation.	X								
9. Lines and hoses - check for leaks and cuts.		X							
10. Diverter valve - check for leaks.		X							
<b>Indicators</b>									
1. Validate rung alignment operation; pedestal and bucket.	X								
2. PTO engaged in cab.	X								
3. Aerial alignment light for cradle bedding	X								
4. Elevation/inclometer in bucket		X							
5. Inclometer in turntable area for truck level		X							



OPERATIONS	Daily	Weekly	Mon	Tue	Wed	Thur	Fri	Sat	Sun
<b>Brakes</b>									
1. Check air system for proper air pressure (see tech manual).	X								
2. Check parking brake operation.	X								
3. Check air compressor operations. Cut in _____ Cut out _____	X								
4. Check hoses or lines for rubbing.		X							
5. Drain wet air tank to make sure air dryer is working properly.		X							
<b>Pump</b>									
1. Operate pump, check pump panel engine gauges.	X								
2. Check pump for pressure operation.	X								
3. Check discharge relief or pressure governor operation.	X								
4. Check all pump drain valves.		X							
5. Check all discharge and intake valve operation.		X							
6. Check pump and tank for water leaks.		X							
7. Check all valve bleeder/drain operation.		X							
8. Check primer pump operation.		X							
9. Check system vacuum hold.		X							
10. Check water tank level indicator.		X							
11. Check primer oil level (if applicable).		X							
12. Check transfer valve operation (if equipped).		X							
13. Check booster reel operation (if equipped).		X							
14. Check all pump pressure gauge operation.	X								
15. Check all cooler valves.		X							
16. Check for oil leaks in pump area.		X							
17. Check oil level of pump transmission.		X							
18. Check hour meter operation.	X								
19. Check operation of valve linkage.	X								
20. Check ball valves for leaks.		X							
21. Check drain valves.		X							
<b>Generator</b>									
1. Operations - Hydraulic, Gas, or Diesel	X								
2. Fluid levels	X								
3. Breakers, Receptacles, lighting for operations		X							
4. Voltage Reading, 240V AC		X							
Amp Reading		X							
HTZ Reading, 60HTZ		X							
<b>Aerial Device</b>									
1. Visually inspect aerial structure, slide blocks, cables, sheaves, and any moving assembly.	X								
a. Sheaves - Look for signs of wear	X								
b. Slide blocks - all in place (no visible signs of excess wear or damage).	X								
2. Check aerial operation - all controls, bucket, and pedestal.	X								
3. Elevation cylinder, check for leaks and wiper seal (check RAM for pits and/or damage)		X							
4. Extension cylinder, check for leaks and wiper seal (check RAM for pits and/or damage).		X							
5. Lines and hoses - check for leaks and cuts.		X							
6. Check aerial hour meter operation and record hours.		X							
7. Check breathing air system.	X								
8. Cable adjustment not too tight and not too loose check all cables and sections. Review tolerance. (See directions in manual supplied to fire department 28 Oct 2014)		X							
9. Observe operation of cable track system and check for debris and/or damage.		X							





**FAMILY OWNED  
SINCE 1890**

# Draining & Winterizing Trucks

It is critical, especially during the cold months, to exercise caution when it comes to leaving trucks outside, transporting trucks, or accepting trucks into our possession. Anyone who gets behind the wheel of a truck is responsible for ensuring the truck is properly drained and stored.

## **Sutphen Guidelines for Draining and Winterizing Trucks**

1. Communicate to all that water and foam tanks must be emptied prior to dropping any truck off to Sutphen for service.
2. Drain all trucks left outside completely, including water tanks, pumps, gauges and valves.
3. Ensure all valves (outboard and inline) are open 50% to drain trapped water.
  - Use caution if valve appears to be frozen in place; do not force a valve open or closed. Trucks may need warmed-up prior to operating frozen valves.
4. Run "RV antifreeze" through the foam pump and systems immediately after foam testing (approx. 3 gal.) from October through April.
5. Any truck being "Road Tested" needs to have all valves and drains open 50% to drain any trapped water. After road testing, the tank fill needs to be opened 100% to allow draining back into the pump. Ensure tank fill is turned back to 50% open after tank has fully drained back into the pump.

Please ensure everyone is fully aware of the expectations and follows the same guidelines. Thank you for your cooperation and dedication to avoiding costly repairs.

**Sutphen Corporation**  
PO Box 158 • Amlin, OH 43002-0158  
6450 Eiterman Road • Dublin, OH 43016-8711  
**Tel 614 889-1005 • Toll Free 800 848-5860 • Fax 614 889-0874**  
**[www.sutphen.com](http://www.sutphen.com) • [Sutphen@sutphencorp.com](mailto:Sutphen@sutphencorp.com)**







---

## Chapter 3 Warranty

	<u>Page</u>
Aerial Platform or Aerial Ladder Structural and Corrosion Warranty	
Thirty (30) Years.....	3-3
Aerial Platform and Aerial Ladder Mechanical Warranty	
Two (2) Years .....	3-4





## AERIAL PLATFORM OR AERIAL LADDER STRUCTURAL & CORROSION WARRANTY THIRTY (30) YEARS

SUTPHEN CORPORATION (Sutphen) warrants the original user/purchaser that a new aerial platform or aerial ladder is, and will remain, free of corrosion perforation and structural defects, provided the aerial platform is used in a normal and reasonable manner. An aerial platform or aerial ladder is defined as the mechanically operated telescopic boom constructed of high-strength structural aluminum mounted on the fire truck. Excluded are all hardware, mechanical or electrical items, bucket, yoke and all normal wear items. Truck must be third party tested yearly. The Sutphen hourly maintenance schedule must be sent in to Sutphen for documentation that this work was performed per hourly schedule. This Structural Warranty shall supplement the Standard Vehicle Warranty.

Sutphen's obligation under this limited warranty is subject to the conditions precedent (1) that the claimed failure shall have first appeared during the warranty period; (2) that the original purchaser shall have notified Sutphen in writing of the claimed failure within thirty (30) days after the claimed failure shall have first appeared, and (3) that, unless Sutphen directs otherwise, the claimed failed item or items shall have been returned to Sutphen, or to Sutphen designee, promptly after the notification, with transportation charges prepaid. Sutphen reserves the right to thoroughly examine the vehicle or parts thereof, prior to conducting or approving any repair or replacement, to determine whether the claimed failure is covered by this warranty. Sutphen's obligation under this warranty is strictly limited to repair or replacement as the company may elect.

This limited warranty coverage shall be valid for a period of thirty (30) years from the delivery date to the original user/purchaser. Further, this warranty shall be void if the vehicle is involved in an accident, shows signs of abuse, or evidence of being operated in any improper manner.

This limited warranty covers only repair or replacement of any part of a Sutphen vehicle in which a defect in materials or workmanship appears within the limited warranty period. Examples of items not covered include, but are not limited to:

- A. ---Major components or trade accessories such as purchased chassis, engines, signaling devices, batteries, generators, tires, or transmissions that have a separate warranty by the original manufacturer, or to equipment used in fire fighting.
- B. ---Unauthorized alteration or modification to the vehicle, including the body, chassis or components, after completion of the vehicle assembly by Sutphen and any problems that occur as a result of such alterations or modifications.
- C. ---Damage caused by collision, fire, theft, freezing, vandalism, riot, explosion, acts of God, war or objects striking the vehicle or any damage covered by owner insurance.
- D. ---Damage caused by misuse or improper operation of the vehicle such as driving over curbs, overloading, racing or off-road use.
- E. ---Damage caused by failure to follow the requirements of the maintenance schedule, failure to maintain proper fluid and lubricant levels and failure to follow operating instructions.
- F. ---Towing charges and storage expenses.
- G. ---Incidental expenses such as loss of vehicle use, inconvenience, loss of time, vehicle rental, lodging or travel costs, vacation pay, etc.
- H. ---Hydraulic pressures are not set to the correct PSI
- I. ---Damage caused from exposure to road de-icing compounds or use in an acidic environment.
- J. ---Hydraulic failures caused by incorrect or contaminated oil.
- K. ---Hydraulic cylinder seal after one (1) year of service.

If proper maintenance has not been performed and documented on Sutphen Aerial Platform or Aerial Ladder Inspection forms and the forms sent to Sutphen at the time of check, all coverage is void.

This warranty terminates upon transfer of possession or ownership of the vehicle from the original purchaser.

THIS WARRANTY IS PROVIDED IN EXCLUSION OF ANY AND ALL OTHER REPRESENTATIONS, EITHER EXPRESSED OR IMPLIED, INCLUDING BUT NOT LIMITED TO THE WARRANTIES OF MERCHANTABILITY, FITNESS, AND SUITABILITY FOR BUYER'S INTENDED USE. NO PERSON IS AUTHORIZED TO MAKE ANY REPRESENTATIONS OR WARRANTIES ON BEHALF OF SUTPHEN CORPORATION OTHER THAN SET FORTH HEREIN. ANY MODIFICATION TO THIS WARRANTY MUST BE IN WRITING AND APPROVED BY THE PRESIDENT OF SUTPHEN CORPORATION. THE PROVISIONS OF THIS LIMITED WARRANTY SHALL CONSTITUTE THE SOLE AND EXCLUSIVE REMEDIES OF A SUTPHEN VEHICLE PURCHASER.

For more information contact:  
Sutphen Corporation / Warranty Admin.  
PO Box 1845 • Springfield, OH 45501  
Phone (937) 969-8851 • Toll Free (866) 287-5549





## AERIAL PLATFORM AND AERIAL LADDER MECHANICAL WARRANTY TWO (2) YEARS

SUTPHEN CORPORATION (Sutphen) warrants the original user/purchaser that the mechanical components of a new aerial platform or aerial ladder is, and will remain, free of corrosion perforation, structural defects or failure provided that the components are used in a normal and reasonable manner. Mechanical components are defined as the hardware and mechanical items used on an aerial device. This Mechanical Warranty shall supplement the Standard Vehicle Warranty.

Sutphen's obligation under this limited warranty is subject to the conditions precedent (1) that the claimed failure shall have first appeared during the warranty period; (2) that the original purchaser shall have notified Sutphen in writing of the claimed failure within thirty (30) days after the claimed failure shall have first appeared, and (3) that, unless Sutphen directs otherwise, the claimed failed item or items shall have been returned to Sutphen, or to Sutphen designee, promptly after the notification, with transportation charges prepaid. Sutphen reserves the right to thoroughly examine the vehicle or parts thereof, prior to conducting or approving any repair or replacement, to determine whether the claimed failure is covered by this warranty. Sutphen's obligation under this warranty is strictly limited to repair or replacement as the company may elect.

This limited warranty coverage shall be valid for a period of two (2) years from the delivery date to the original user/purchaser. Further, this warranty shall be void if the vehicle is involved in an accident, shows signs of abuse, or evidence of being operated in an improper manner.

This limited warranty covers only repair or replacement of any part of a Sutphen vehicle in which a defect in materials or workmanship appears within the limited warranty period. Examples of items not covered include, but are not limited to:

- A. ---Major components or trade accessories that have a separate warranty by the original manufacturer, or equipment used in fire fighting.
- B. ---Unauthorized alteration or modification to the vehicle, including the aerial, body, chassis or components, after completion of the vehicle assembly by Sutphen and any problems that occur as a result of such alterations or modifications.
- C. ---Damage caused by collision, fire, theft, freezing, vandalism, riot, explosion, acts of God, war or objects striking the vehicle or any damage covered by owner insurance.
- D. ---Damage caused by misuse or improper operation of the vehicle such as driving over curbs, overloading, racing or off-road use.
- E. ---Damage caused by failure to follow the requirements of the maintenance schedule, failure to maintain proper fluid and lubricant levels and failure to follow operating instructions.
- F. ---Normal maintenance items such as lubrication, cables, shives, pivot bearings, pivot shafts, etc.
- G. ---Towing charges and storage expenses.
- H. ---Incidental expenses such as loss of vehicle use, inconvenience, loss of time, vehicle rental, lodging or travel costs, vacation pay, etc.
- I. ---Damage to discharge and compound gauges from freezing.
- J. ---Leaking seals on discharge and suction valves.
- K. ---Damage caused from exposure to road de-icing compounds or use in an acidic environment.
- L. ---Hydraulic failures caused by incorrect or contaminated oil.
- M. ---Hydraulic pressure caused by incorrect PSI settings.
- N. ---Hydraulic cylinder seal after one (1) year service.
- O. ---Electric reels, air reels, electric controls and components.

If proper maintenance has not been performed and documented on Sutphen Aerial Inspection forms and sent to Sutphen at time of check, all coverage is void.

This warranty terminates upon transfer of possession or ownership of the vehicle from the original purchaser.

THIS WARRANTY IS PROVIDED IN EXCLUSION OF ANY AND ALL OTHER REPRESENTATIONS, EITHER EXPRESSED OR IMPLIED, INCLUDING BUT NOT LIMITED TO THE WARRANTIES OF MERCHANTABILITY, FITNESS, AND SUITABILITY FOR BUYER'S INTENDED USE. NO PERSON IS AUTHORIZED TO MAKE ANY REPRESENTATIONS OR WARRANTIES ON BEHALF OF SUTPHEN CORPORATION OTHER THAN SET FORTH HEREIN. ANY MODIFICATION TO THIS WARRANTY MUST BE IN WRITING AND APPROVED BY THE PRESIDENT OF SUTPHEN CORPORATION. THE PROVISIONS OF THIS LIMITED WARRANTY SHALL CONSTITUTE THE SOLE AND EXCLUSIVE REMEDIES OF A SUTPHEN VEHICLE PURCHASER.

For more information contact:  
Sutphen Corporation / Warranty Admin.  
PO Box 1845 • Springfield, OH 45501  
Phone (937) 969-8851 • Toll Free (866) 287-5549